

PRODUCT CATALOGUE

Nudura Insulated Concrete Forms, Insulation Products & Accessories



CONTENTS

Introduction	3
Product Innovation	4
Product Series	5
Nudura ICF Series	
Assembled Forms:	
Standard Form	6
90° Form	7
45° Form	8
Taper Top Form	9
Brick Ledge Form	10
Radius Form	11
T-Form	12
Unassembled Forms:	
Standard Form	13
Taper Top Form	14
Double Sided Taper Top Form	15
Brick Ledge Form	16
Double Sided Brick Ledge Form	17
Brick Ledge & Taper Top Form	18
Optimizer Form	19
One Series	20 - 21
Plus Series	
XR35	22
Nudura Plus Forms	23
R-Value Inserts	24
Integrated Series	
HYDROFOAM®	25
THERMOFOAM®	26
HOMEGA®	27
Nudura Form Accessories	28
Nudura Accessories	29 - 33
Nudura Alignment System	34 - 35
Nudura Tall Wall Adapter Kit	36
Notes	37 - 38



Nudura ICFs are a proven method of providing you a better alternative to traditional building methods

Buildings today demand reliable, energy efficient and eco-friendly building envelopes that provide superior performance benefits to minimise energy costs, reducing carbon emissions, and maximising property value. Nudura structures offer superior strength, disaster resilience, sound and fire-resistance, these are why the design community, developers, and contractors across the world continue to choose Nudura's insulated concrete forms and insulation products as a proven alternative to traditional building methods.

Nudura products provide design professionals, architects, homeowners and contractors the freedom and versatility to design and build a structure the way it was envisioned. Building with Nudura gives you the opportunity to build faster and more efficient, while offering your clients an eco-friendly structure with substantial benefits that contribute to long-term energy savings. When specifying Nudura you can assure your customers that you are using the best building solution available today. Nudura is now proudly part of Tremco Construction Products Group (CPG).

The Tremco CPG Difference

We know that the success of a construction project relies on more than the products that are used, as it takes a lot of skill, knowledge, understanding, and expertise to ensure that those products are applied in the best way possible.

At Tremco Construction Products Group (CPG), we're committed to shaping the future through innovative approaches and sustainable solutions.

This commitment is backed up by the fact that we bring together first-class technology with a customer-focused approach, along with skills that have been built up over multiple decades within very specialised fields across Asia Pacific, to provide a truly unique service.



From joint sealing, façade bonding and insulation through to passive fire protection, performance resin flooring, waterproofing, and roofing solutions — our broad range makes us the ideal partner to solve the complex challenges faced by today's architects, contractors, developers, and trades.

With expertise in a range of product technologies, Tremco CPG provides solutions to help you engineer structures that are more efficient to build and maintain, are virtually impervious to the elements, and can provide a multitude of finishes.

Our brands include Tremco, Dryvit, NewBrick, Nudura, Willseal, Flowcrete, illbruck, Nullifire, Vandex, and Euclid Chemical.

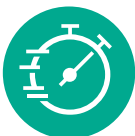

Faster Construction Time

Lightweight, fast-curing and prefabricated products mean less occupant disruption, faster return to service, less revenue lost, and no call-backs.

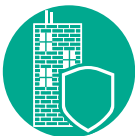

Stronger and More Resilient

Our systems are designed for maximum durability, many with service lives far surpassing that of competing systems.



Cost Effective

A broad range of options that fit any budget — but also help you keep an eye on the future to ensure cost-effective ownership, operation and maintenance.



One Point of Contact

Products are tested for compatibility and backed by system warranties — all through a single point of contact, with a single point of responsibility.



Any Look You Want

A wide range of colours and finishes for floors, walls, façades and roofs to provide almost unlimited design potential for your building project.

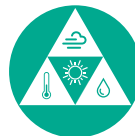

Impervious to Weather

Products designed for maximum protection from the elements, including above and below ground-level solutions to prevent the ingress of water.



Better Insulated

Industry leading brands that provide solutions for more efficient building construction and operation, and exceeding strict energy codes for insulation.



Leading Edge Sustainability

Construction solutions that meet green building standards, enhancing building efficiency and conscious of the environment that surrounds us.

>> For more information, visit www.tremcocpg-asiapacific.com



Nudura ICFs are manufactured with industry leading patented technologies that are exclusive to Nudura, offering you a full line of innovative products designed to provide superior energy efficiency, greater strength, and sound resistance. Our building envelope provides an affordable eco-friendly building solution that allows you to build faster, more efficiently and offers substantial benefits over traditional construction.

Innovation makes us the solution to better building.



- **DURALOK Technology®** - Securely locks forms into place with a triple tooth interlock eliminating the need to wire or glue forms, resulting in reduced labour costs during installation. Once the forms are stacked together a continuous full height-fastening strip ensures wall heights are always accurate, compared to other forms without full height-fastening which can cause wall height shrinkage once concrete is placed. DURALOK Technology® makes Nudura the strongest in the industry.



- **DURAFOLD Technology®** - Patented hinged web technology allows the entire Nudura form line up to fold and ship flat, allowing for 40% more product on a truck compared to other Insulated Concrete Form products. Once on-site, simply unfold and stack.



- **DURAMAX Technology®** - Largest standard form on the market measuring 96" x 18" (2438mm x 457mm). Our 96" (2438mm) form creates 60% fewer joints in the wall compared to other wall systems and allows installers the ability to place 12 sq.ft. (1.11 m²) of wall area with one block.



- **4-WAY REVERSIBLE System** - Patented foam interlock allows the form to be 4-way reversible, eliminating left and right corners, which helps speed up the building process and reduces product waste on-site.

Watch our Innovation Video at [nudura.co.uk/innovation](https://www.nudura.co.uk/innovation)



nudura^{icf} —series—

The Nudura ICF Series is the leader in Insulated Concrete Form Innovation and technology and offers users the ability to combine a variety of products during the building process. The Nudura ICF Series offers unique advantages over other products currently on the market.

DURAMAX Technology®
DURAFOLD Technology®
DURALOK Technology®
The 4-Way Reversible System

one¹ —series—

The One Series was the industry's first multi-link form system that enables the creation of a fully exposed concrete surface that extends to the face of a standard Nudura form panel. This offers builders and architects unmatched versatility for projects designed to use ICFs. At the core of this innovative line is our DURA MULTI-LINK® Technology, a newly designed tie that enables the builder to create custom multi-sided form combinations for a variety of commercial and residential building projects.

plus⁺ —series—

The Plus Series product line introduces an innovative way for designers and engineers to build their own R-value. The Plus Series product line offers the ability to optimise R-Value with thermal mass to provide significant energy savings for building owners. The Nudura Plus Series allows professionals the ability to meet new installation requirements with one product.

integrated[↔] —series—

The Integrated Series from Nudura combines building envelope products that work in conjunction with our line of Insulated Concrete Forms to provide maximum energy efficiency. Each Integrated Series product has been manufactured to install quickly and efficiently and replaces many traditional forms of insulation products that are far more labour intensive.

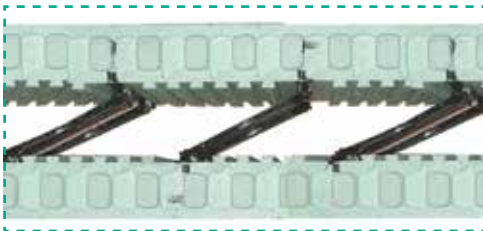

Close view of folding metal-hinged web

Assembled Product Shown Above



MAY WE SUGGEST:

FORM-LOCK

Used to maintain wall straightness. Other uses include wall alignment for vertical stack joints.



Available for 6" (150mm), 8" (200mm), 10" (250mm), 12" (300mm) Standard Forms.

Core Width	6" (152mm)	8" (203mm)	10" (254mm)	12" (305mm)
Length	10' (3m)	10' (3m)	10' (3m)	10' (3m)
Qty./Bundle	10 PCS	10 PCS	10 PCS	10 PCS
Code #	NUS-ABLOK-06	NUS-ABLOK-08	NUS-ABLOK-10	NUS-ABLOK-12

Visit the Resource Center on Nudura's website (nudura.co.uk/resource-center) for design details, BIM library, installation links & more.

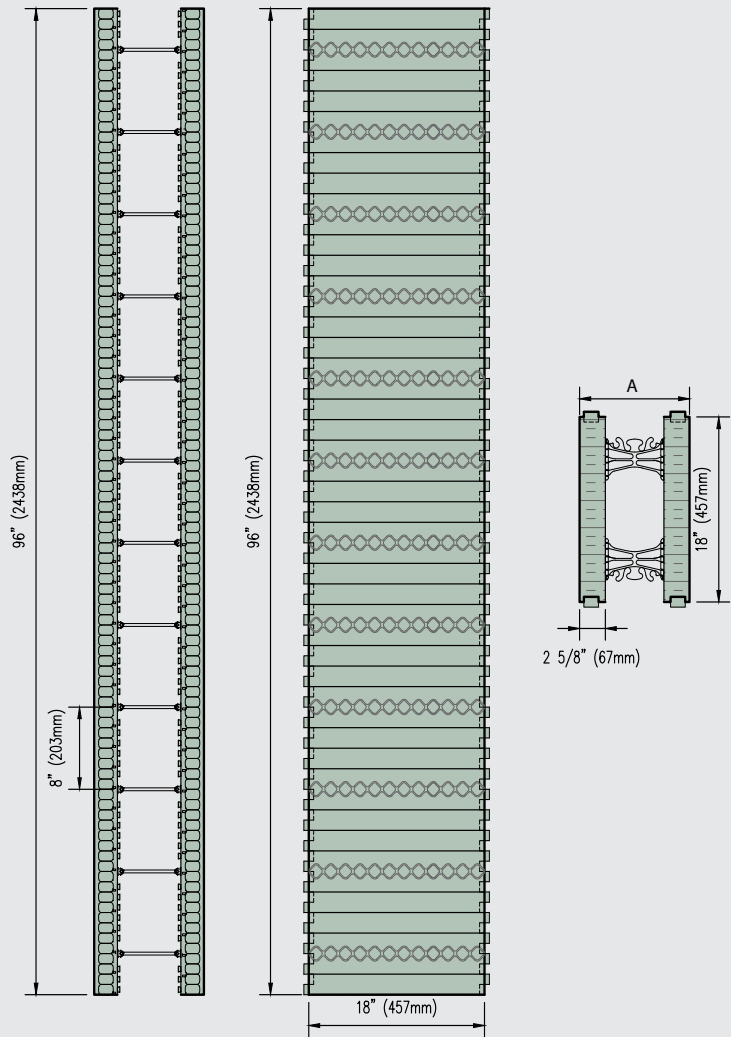

Core Width	4" (102mm)	6" (152mm)	8" (203mm)	10" (254mm)	12" (305mm)
Length	96" (2438mm)	96" (2438mm)	96" (2438mm)	96" (2438mm)	96" (2438mm)
Width A	9 1/4" (235mm)	11 1/4" (286mm)	13 1/4" (337mm)	15 1/4" (387mm)	17 1/4" (438mm)
Height	18" (457mm)	18" (457mm)	18" (457mm)	18" (457mm)	18" (457mm)
EPS Thickness	2 5/8" (67mm)	2 5/8" (67mm)	2 5/8" (67mm)	2 5/8" (67mm)	2 5/8" (67mm)
Qty./Bundle	3	3	3	3	3
Code #	NUS-10096-04	NUS-10096-06	NUS-10096-08	NUS-10096-10	NUS-10096-12

Units come assembled with folding, metal-hinged webs.

Webs are included with assembled units.

Refer to pages 28-33 for all related product accessories & tools. For additional information visit nudura.co.uk.

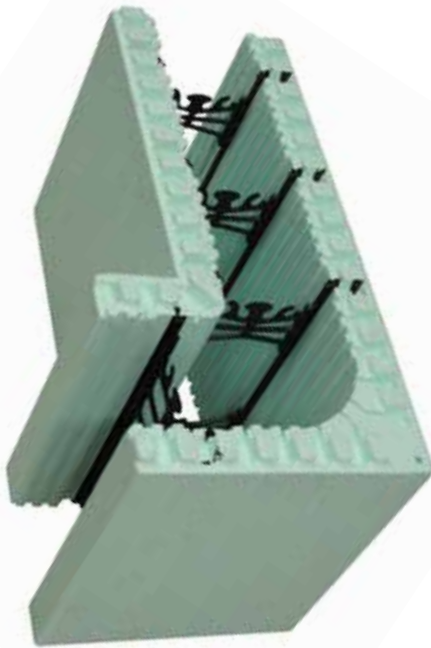

View of folding metal-hinged web and insert web for angled corner (included in order).

Assembled Product Shown Above



MAY WE SUGGEST:

Vertical Joint Clip

This metal clip is designed to connect the form together at the vertical joints. It replaces having to tie wire or tape forms together while providing a solid connection using minimal amount of labour to install.



Qty./Box	200 PCS
Code #	NUS-A0VIC-00

Visit the Resource Center on Nudura's website (nudura.co.uk/resource-center) for design details, BIM library, installation links & more.

Refer to pages 28-33 for all related product accessories & tools. For additional information visit nudura.co.uk.

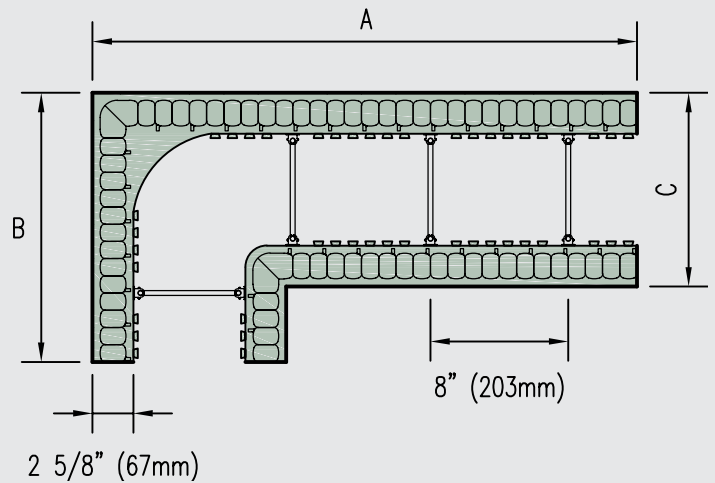
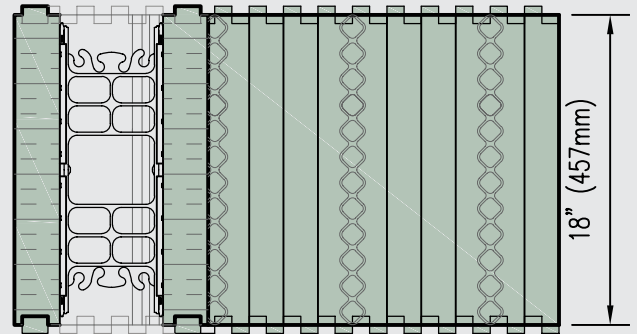

Core Width	4" (102mm)	6" (152mm)	8" (203mm)	10" (254mm)	12" (305mm)
Length A	31 5/8" (803mm)	31 5/8" (803mm)	33 5/8" (854mm)	35 5/8" (905mm)	37 5/8" (956mm)
Length B	15 5/8" (397mm)	15 5/8" (397mm)	17 5/8" (448mm)	19 5/8" (498mm)	21 5/8" (549mm)
Width C	9 1/4" (235mm)	11 1/4" (286mm)	13 1/4" (337mm)	15 1/4" (387mm)	17 1/4" (438mm)
Height	18" (457mm)	18" (457mm)	18" (457mm)	18" (457mm)	18" (457mm)
Qty./Bundle	6	6	6	4	4
Code #	NUS-10090-04	NUS-10090-06	NUS-10090-08	NUS-10090-10	NUS-10090-12

Units come assembled with folding, metal-hinged webs.

Webs are included with assembled units.



View of folding metal-hinged web and insert web for angled corner (included in order).

Assembled Product Shown Above

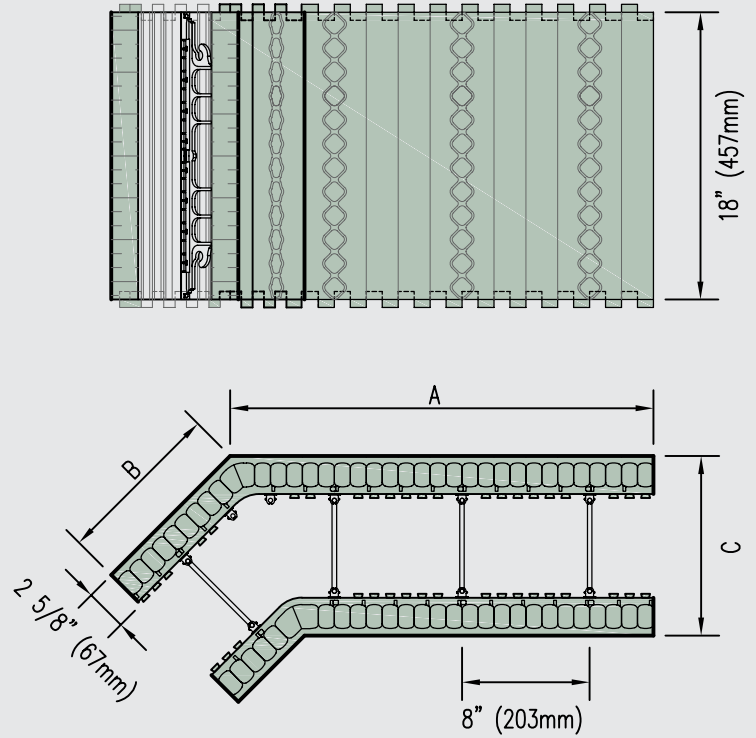

MAY WE SUGGEST:

Vertical Joint Clip

This metal clip is designed to connect the form together at the vertical joints. It replaces having to tie wire or tape forms together while providing a solid connection using minimal amount of labour to install.



Qty./Box	200 PCS
Code #	NUS-A0VIC-00

Visit the Resource Center on Nudura's website (nudura.co.uk/resource-center) for design details, BIM library, installation links & more.

Refer to pages 28-33 for all related product accessories & tools. For additional information visit nudura.co.uk.

Core Width	4" (102mm)	6" (152mm)	8" (203mm)	10" (254mm)	12" (305mm)
Length A	26 1/2" (673mm)	26 1/2" (673mm)	26 1/2" (673mm)	28 1/2" (724mm)	30 1/2" (775mm)
Length B	10 1/2" (267mm)	10 1/2" (267mm)	10 1/2" (267mm)	12 1/2" (318mm)	14 1/2" (368mm)
Width C	9 1/4" (235mm)	11 1/4" (286mm)	13 1/4" (337mm)	15 1/4" (387mm)	17 1/4" (438mm)
Height	18" (457mm)	18" (457mm)	18" (457mm)	18" (457mm)	18" (457mm)
Qty./Bundle	6	6	6	4	4
Code #	NUS-10045-04	NUS-10045-06	NUS-10045-08	NUS-10045-10	NUS-10045-12

Units come assembled with folding, metal-hinged webs.

Webs are included with assembled units.

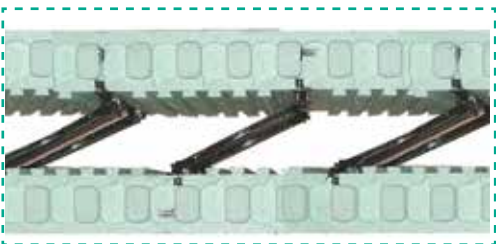

Close view of folding metal-hinged web

Assembled Product Shown Above



MAY WE SUGGEST:

4" Heavy Duty Tape

Used for covering the interlock at the top of a wall to protect it from concrete getting into the interlock.



Qty./Box	24 PCS
Code #	NUS-ATPHD-04
Dimensions	4" x 72 Yd (96mm x 66m)

Visit the Resource Center on Nudura's website (nudura.co.uk/resource-center) for design details, BIM library, installation links & more.

Refer to pages 28-33 for all related product accessories & tools.
For additional information visit nudura.co.uk.

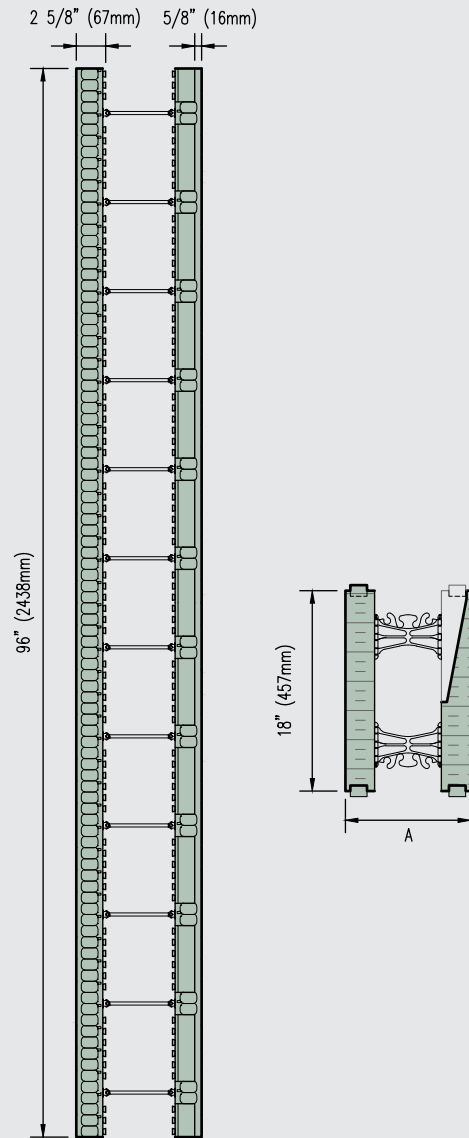

Core Width	4" (102mm)	6" (152mm)	8" (203mm)	10" (254mm)	12" (305mm)
Overall Width A	9 1/4" (235mm)	11 1/4" (286mm)	13 1/4" (337mm)	15 1/4" (387mm)	17 1/4" (438mm)
Length - 96"		96" (2438mm)	96" (2438mm)		
Qty./Bundle		3	3		
Code #		NUS-IOT96-06	NUS-IOT96-08		

 Units come assembled with folding, metal-hinged webs.

 Only available as an unassembled Form Unit. Refer to page 14 for order information.

Webbs are included with assembled units.

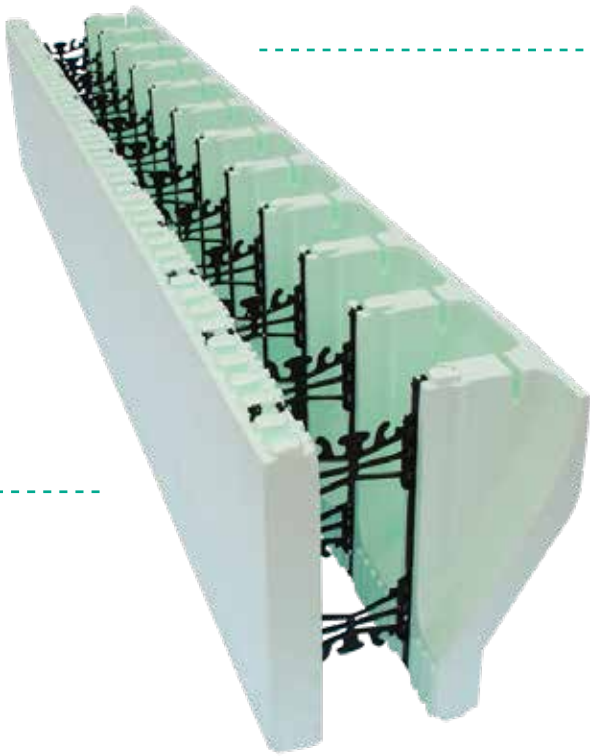

Close view of folding metal-hinged web

Assembled Product Shown Above



MAY WE SUGGEST:

Brick Ledge Extension

Used for supporting standard brick or stone veneer finishes, when constructing brick ledges at corners, and can be installed to meet any elevation change or slope.



Qty./Bundle	14
Code #	NUS-ABLEX-00

Refer to page 28 for more order information.

Refer to pages 28-33 for all related product accessories & tools.
For additional information visit nudura.co.uk.

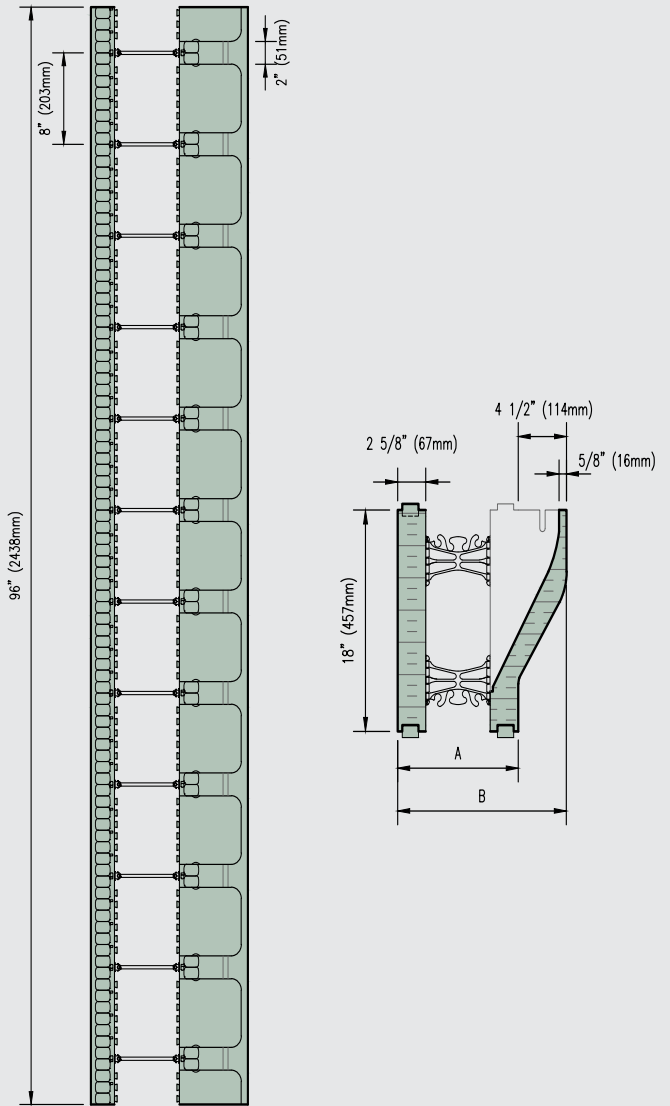

Assembled 96" (2438mm) Molded Brick Ledge Shown Above

Core Width	4" (102mm)	6" (152mm)	8" (203mm)	10" (254mm)	12" (305mm)
Width A		11 1/4" (268mm)			
Width B		15 3/4" (400mm)			
Length - 48"		48" (1219mm)			
Qty./Bundle		4			
Code #		NUS-10B48-06			
Length - 96"		96" (2438mm)			
Qty./Bundle		2			
Code #		NUS-10B96-06			

 Units come assembled with folding, metal-hinged webs.

 Only available as an unassembled Form Unit. Refer to page 16 for order information.

Webbs are included with assembled units.

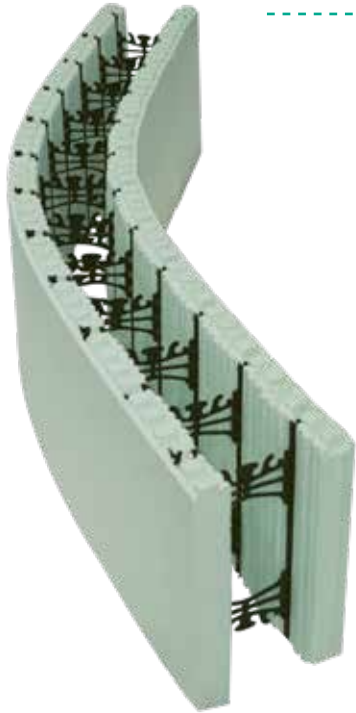

Close view of folding metal-hinged web

Assembled Product Shown Above



MAY WE SUGGEST:

NUBASE Parging Mix and Fiber Mesh

The parge mix is a dry cementitious product that is used to cover exposed EPS that is not covered by an exterior finish. Used in conjunction with Fiber Mesh. The Fiber Mesh gets embedded into the parge coat to give it strength.



Parging Mix
Coverage - 75 sq ft (7m²)



Fiber Mesh
Coverage - 475 sq ft (44m²)

Qty./Each	1 BAG
Code #	NUS-APARG-00

Qty./Each	1 ROLL
Code #	NUS-AMESH-00

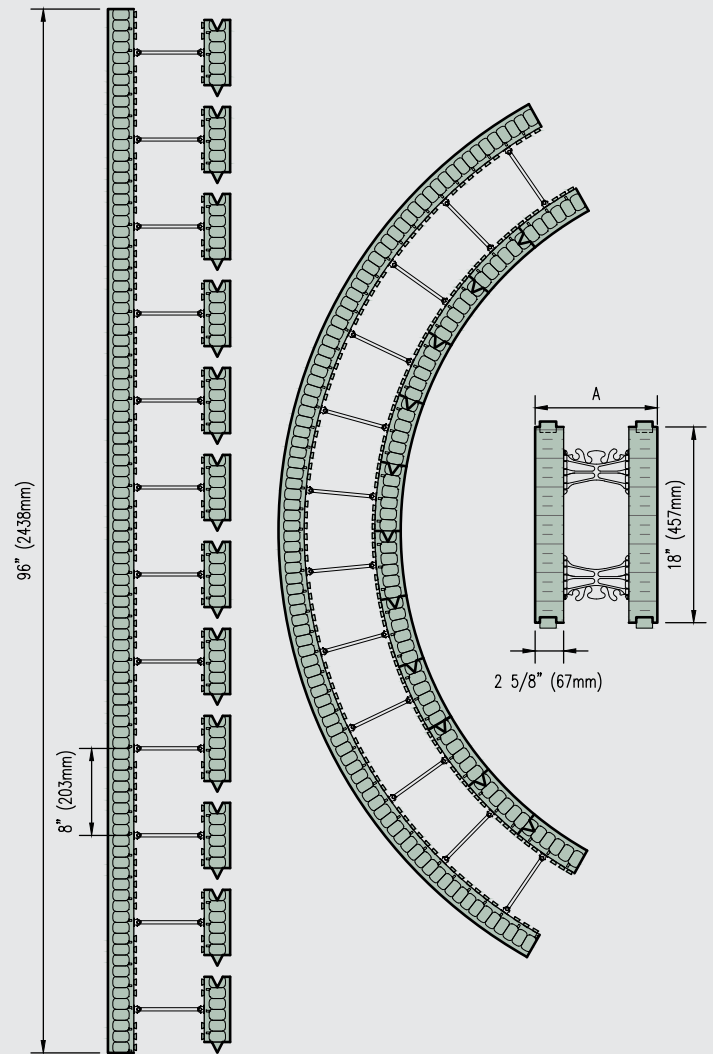

Core Width	4" (102mm)	6" (152mm)	8" (203mm)	10" (254mm)	12" (305mm)
Length	96" (2438mm)	96" (2438mm)	96" (2438mm)	96" (2438mm)	96" (2438mm)
Width A	9 1/4" (235mm)	11 1/4" (286mm)	13 1/4" (337mm)	15 1/4" (387mm)	17 1/4" (438mm)
Height	18" (457mm)	18" (457mm)	18" (457mm)	18" (457mm)	18" (457mm)
Radius	Manufactured to Specifications.				
Qty./Bundle	Varies with radius size. Contact your local distributor for details.				
Code #	NUS-IORAD-04	NUS-IORAD-06	NUS-IORAD-08	NUS-IORAD-10	NUS-IORAD-12

Units come assembled with folding, metal-hinged webs.

Refer to Nudura's Installation Manual for the Radius Form Calculator.

Visit the Resource Center on Nudura's website (nudura.co.uk/resource-center) for design details, BIM library, installation links & more.

Refer to pages 28-33 for all related product accessories & tools. For additional information visit nudura.co.uk.

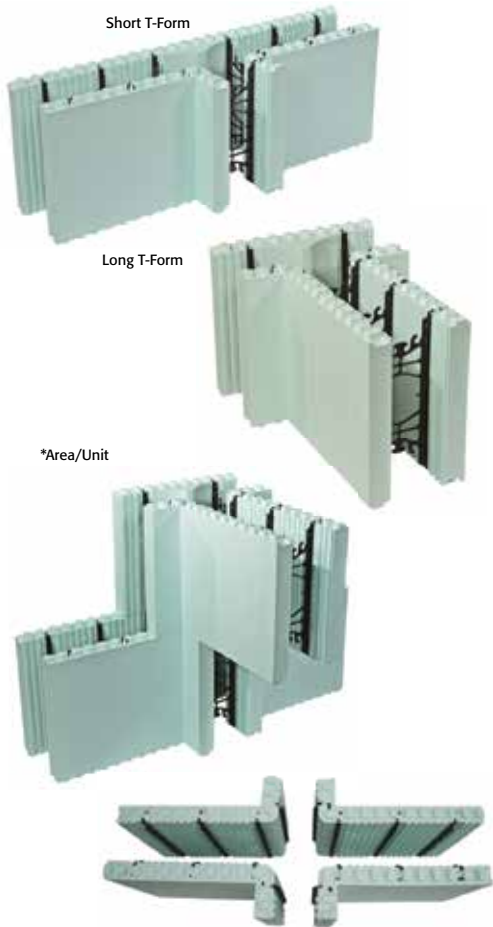

*Area/Unit

NUS-I0STW-00** T-Cross - Webs ordered separately.



Close view of insert webs - Webs are included with order.

Webs are Included - Site Assembly Required

Refer to pages 28-33 for all related product accessories & tools.
For additional information visit nudura.co.uk.

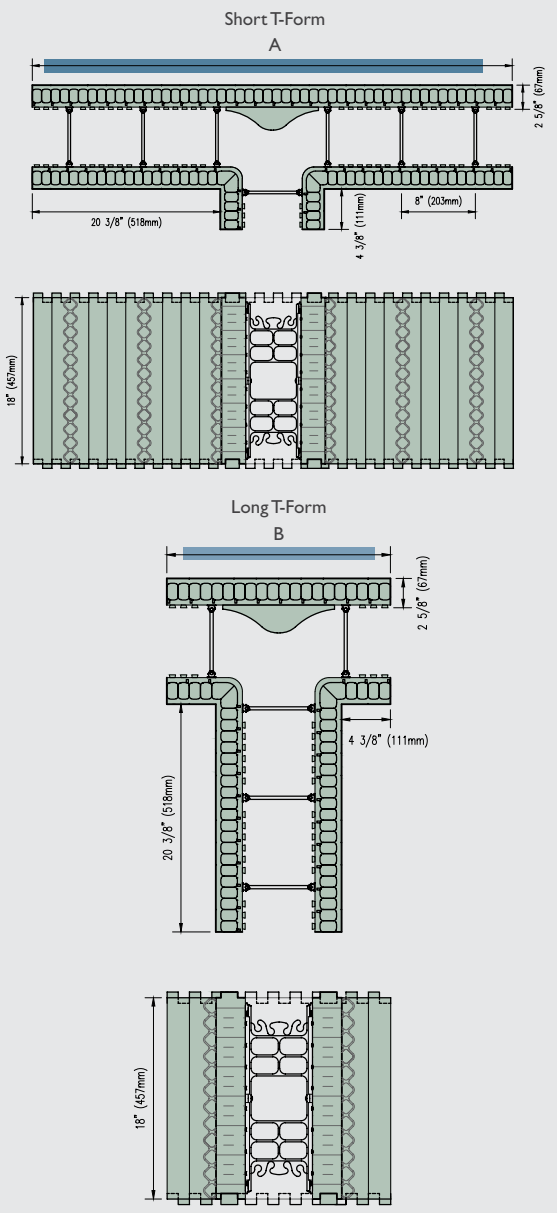

For more form dimensions refer to Nudura's Installation Manual.

Bundle Includes 4 Courses - 2 Short and 2 Long T-Forms

Main Wall - represents the concrete core of the outside form
Interior Wall "T" - represents the concrete core of the inside form that joins to the Main Wall

Core Width	Short T-Form Length (A)	Long T-Form Length (B)	Area/Unit*	Bundle Code #
6" (152mm)	52" (1321mm)	20" (508mm)	12 ft ² (1.115 m ²)	NUS-I0T06-06
8" (203mm)	54" (1372mm)	22" (559mm)	12 1/2 ft ² (1.161m ²)	NUS-I0T08-08

**** Special Order:** Code # NUS-I0STW-00: T-Cross Form Unit Unassembled - 4 panels per T-Cross (4 T-Cross Form Units per bundle) - 32 webs required per bundle. Webs ordered separately.
Refer to next page for web order information.

Short T-Form Main Exterior Wall Length. Webs are included. Long T-Form Main Exterior Wall Length. Webs are included.

*Area/Unit - a unit represents one Short T-Form and one Long T-Form connected together forming 2 courses (reference photo above).

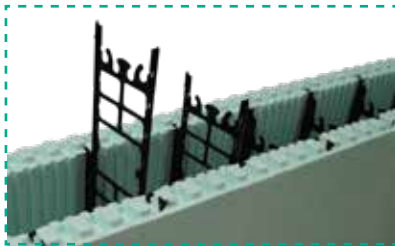
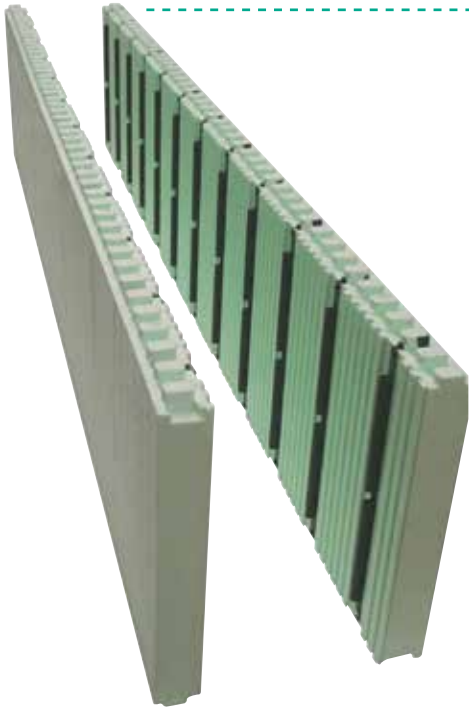

Close view of insert webs - available in 4"-12" (102-305mm) sizes

Unassembled Product Shown Above

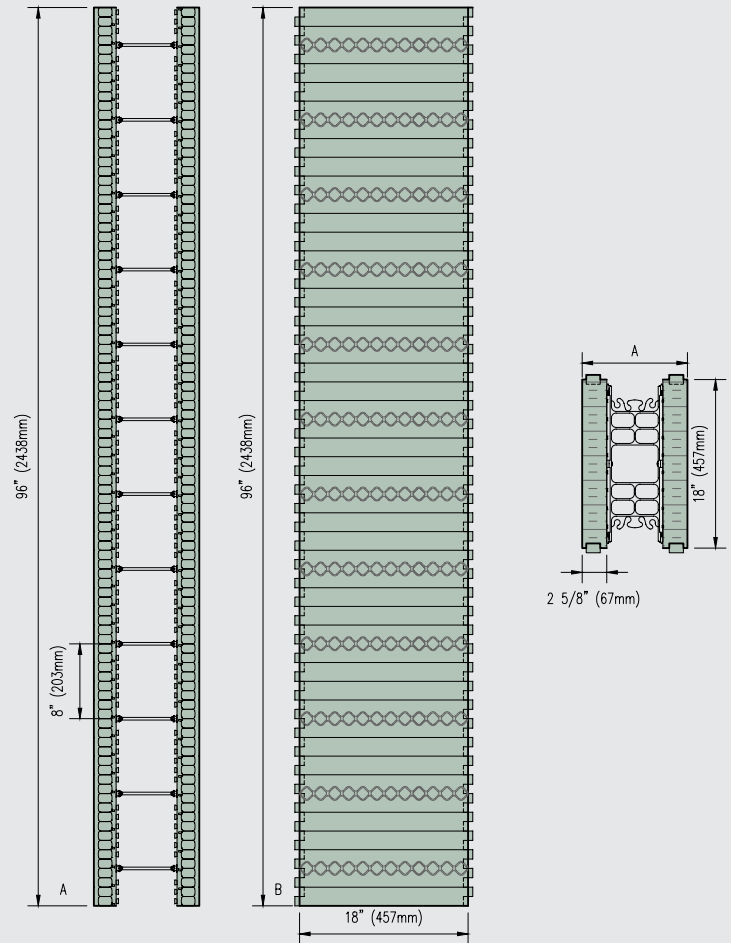

Insert Webs (Ordered Separately)

Small Box

Core Width	4" (102mm)	6" (152mm)	8" (203mm)	10" (254mm)	12" (305mm)
Qty./Box	100	100	100	100	100
Code #	NUS-IWEBS-04	NUS-IWEBS-06	NUS-IWEBS-08	NUS-IWEBS-10	NUS-IWEBS-12

Large Box

Core Width	4" (102mm)	6" (152mm)	8" (203mm)	10" (254mm)	12" (305mm)
Qty./Box	957	655	465	388	295
Code #	NUS-IWEBL-04	NUS-IWEBL-06	NUS-IWEBL-08	NUS-IWEBL-10	NUS-IWEBL-12

Visit the Resource Center on Nudura's website (nudura.co.uk/resource-center) for design details, BIM library, installation links & more.

Core Width	4" (102mm)	6" (152mm)	8" (203mm)	10" (254mm)	12" (305mm)
Length	96" (2438mm)	96" (2438mm)	96" (2438mm)	96" (2438mm)	96" (2438mm)
Width A	9 1/4" (235mm)	11 1/4" (286mm)	13 1/4" (337mm)	15 1/4" (387mm)	17 1/4" (438mm)
Height	18" (457mm)	18" (457mm)	18" (457mm)	18" (457mm)	18" (457mm)
Qty./Bundle	Includes: 6 Standard Panels (3 pairs per bundle)				
Code #	NUS-IOPAN-00	NUS-IOPAN-00	NUS-IOPAN-00	NUS-IOPAN-00	NUS-IOPAN-00
Web Qty. Req'd/Bundle	36	36	36	36	36

Units come unassembled.

Insert webs required per bundle - refer to web order chart on left.

Refer to pages 28-33 for all related product accessories & tools. For additional information visit nudura.co.uk.

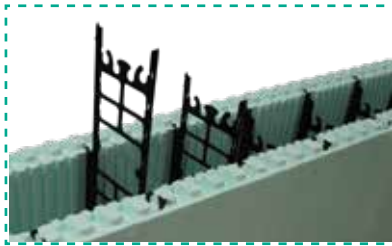

Close view of insert webs - available in 4"-12" (102-305mm) sizes

Unassembled Product Shown Above

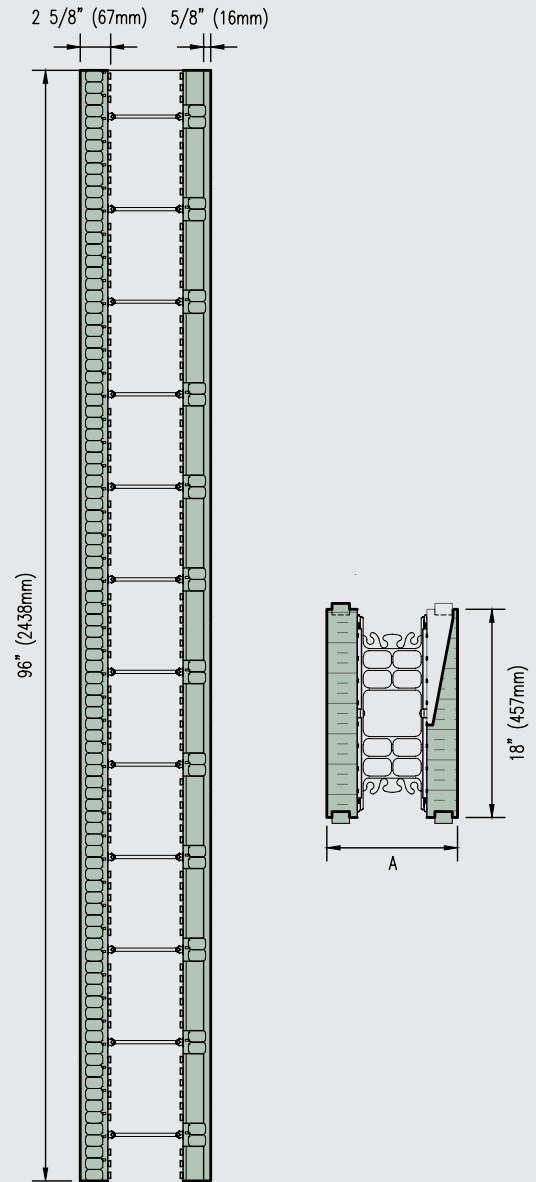

Insert Webs (Ordered Separately)

Small Box

Core Width	4" (102mm)	6" (152mm)	8" (203mm)	10" (254mm)	12" (305mm)
Qty./Box	100	100	100	100	100
Code #	NUS-IWEBS-04	NUS-IWEBS-06	NUS-IWEBS-08	NUS-IWEBS-10	NUS-IWEBS-12

Large Box

Core Width	4" (102mm)	6" (152mm)	8" (203mm)	10" (254mm)	12" (305mm)
Qty./Box	957	655	465	388	295
Code #	NUS-IWEBL-04	NUS-IWEBL-06	NUS-IWEBL-08	NUS-IWEBL-10	NUS-IWEBL-12

Visit the Resource Center on Nudura's website (nudura.co.uk/resource-center) for design details, BIM library, installation links & more.

Core Width	4" (102mm)	6" (152mm)	8" (203mm)	10" (254mm)	12" (305mm)
Overall Width A	9 1/4" (235mm)	11 1/4" (286mm)	13 1/4" (337mm)	15 1/4" (387mm)	17 1/4" (438mm)
Length - 96"	96" (2438mm)	96" (2438mm)	96" (2438mm)	96" (2438mm)	96" (2438mm)
Qty./Bundle	Includes: 3 Taper Top Panels & 3 Standard Panels				
Code #	NUS-IOT96-00	NUS-IOT96-00	NUS-IOT96-00	NUS-IOT96-00	NUS-IOT96-00
Web Qty. Req'd/Bundle	36	36	36	36	36

Units come unassembled.

Insert webs required per bundle - refer to web order chart on left.

Refer to pages 28-33 for all related product accessories & tools. For additional information visit nudura.co.uk.

Double Sided Taper Top - Unassembled

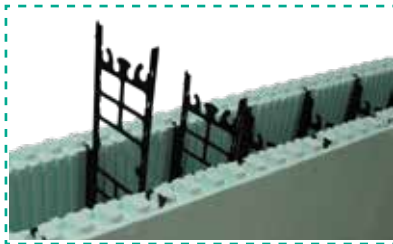

Close view of insert webs - available in 4"-12" (102-305mm) sizes

Unassembled Product Shown Above

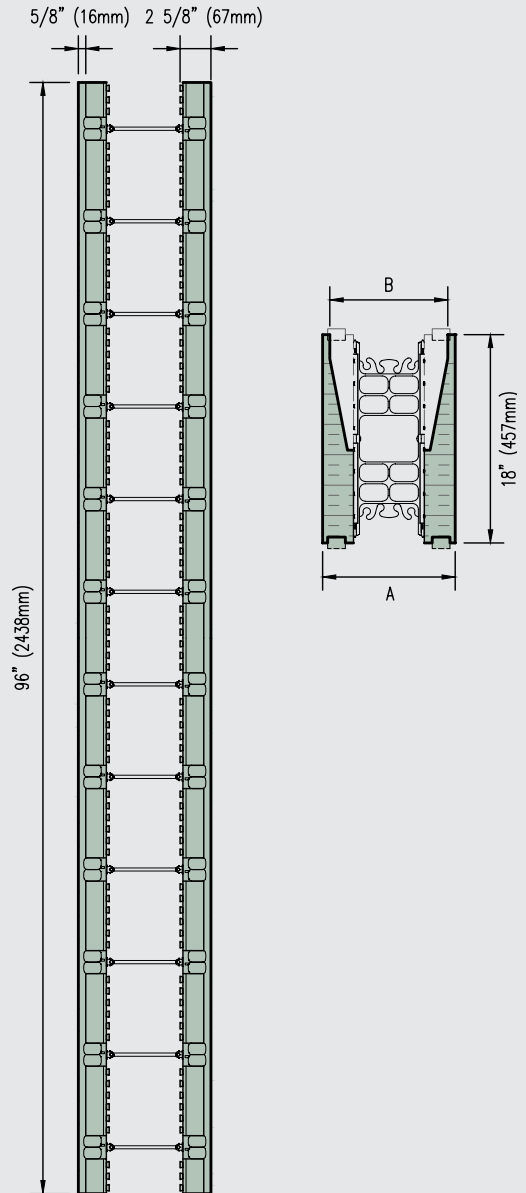

Insert Webs (Ordered Separately)

Small Box

Core Width	4" (102mm)	6" (152mm)	8" (203mm)	10" (254mm)	12" (305mm)
Qty./Box	100	100	100	100	100
Code #	NUS-IWEBS-04	NUS-IWEBS-06	NUS-IWEBS-08	NUS-IWEBS-10	NUS-IWEBS-12

Large Box

Core Width	4" (102mm)	6" (152mm)	8" (203mm)	10" (254mm)	12" (305mm)
Qty./Box	957	655	465	388	295
Code #	NUS-IWEBL-04	NUS-IWEBL-06	NUS-IWEBL-08	NUS-IWEBL-10	NUS-IWEBL-12

Visit the Resource Center on Nudura's website (nudura.co.uk/resource-center) for design details, BIM library, installation links & more.

Core Width	4" (102mm)	6" (152mm)	8" (203mm)	10" (254mm)	12" (305mm)
Overall Width A	9 1/4" (235mm)	11 1/4" (286mm)	13 1/4" (337mm)	15 1/4" (387mm)	17 1/4" (438mm)
Overall Width B	8" (203mm)	10" (254mm)	12" (305mm)	14" (356mm)	16" (406mm)
Length - 96"	96" (2438mm)	96" (2438mm)	96" (2438mm)	96" (2438mm)	96" (2438mm)
Qty./Bundle	Includes: 6 Taper Top Panels				
Code #	NUS-IOD96-00	NUS-IOD96-00	NUS-IOD96-00	NUS-IOD96-00	NUS-IOD96-00
Web Qty. Req'd/Bundle	36	36	36	36	36

Units come unassembled.

*Available assembled - 3 units/bundle (webs included):

6" (150mm) - NUS-IOD96-06

8" (200mm) - NUS-IOD96-08

Insert webs required per bundle - refer to web order chart on left.

Refer to pages 28-33 for all related product accessories & tools.
For additional information visit nudura.co.uk.

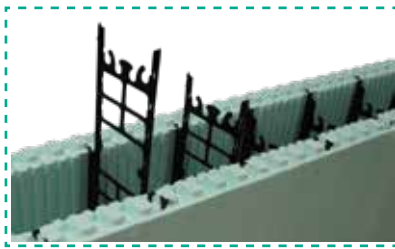

Close view of insert webs - available in 4"-12" (102-305mm) sizes

Unassembled Product Shown Above

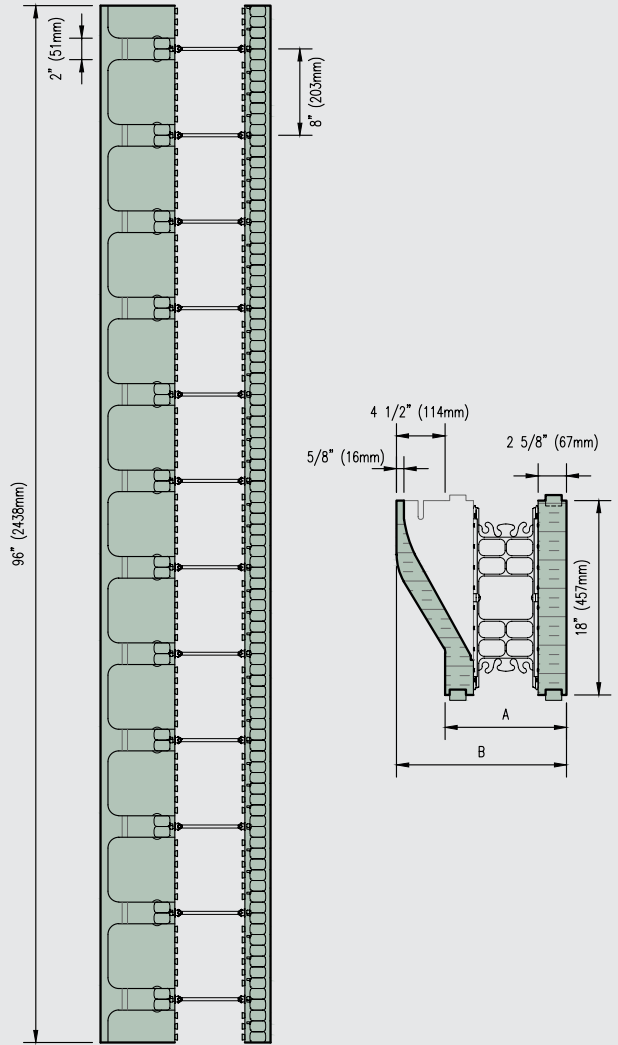

Unassembled 96" (2438mm) Molded Brick Ledge Shown Above

Insert Webs (Ordered Separately)

Small Box

Core Width	4" (102mm)	6" (152mm)	8" (203mm)	10" (254mm)	12" (305mm)
Qty./Box	100	100	100	100	100
Code #	NUS-IWEBS-04	NUS-IWEBS-06	NUS-IWEBS-08	NUS-IWEBS-10	NUS-IWEBS-12

Large Box

Core Width	4" (102mm)	6" (152mm)	8" (203mm)	10" (254mm)	12" (305mm)
Qty./Box	957	655	465	388	295
Code #	NUS-IWEBL-04	NUS-IWEBL-06	NUS-IWEBL-08	NUS-IWEBL-10	NUS-IWEBL-12

Visit the Resource Center on Nudura's website (nudura.co.uk/resource-center) for design details, BIM library, installation links & more.

Core Width	4" (102mm)	6" (152mm)	8" (203mm)	10" (254mm)	12" (305mm)
Overall Width A	9 1/4" (235mm)	11 1/4" (286mm)	13 1/4" (337mm)	15 1/4" (387mm)	17 1/4" (438mm)
Overall Width B	13 3/4" (349mm)	15 3/4" (400mm)	17 3/4" (451mm)	19 3/4" (502mm)	21 3/4" (552mm)
48" requires one Brick Ledge Panel & one Standard Panel to assemble one form unit					
Length - 48"	48" (1219mm)	48" (1219mm)	48" (1219mm)	48" (1219mm)	48" (1219mm)
Qty./Bundle	Includes: 4 Brick Ledge Panels & 4 Standard Panels				
Code #	NUS-10B48-00	NUS-10B48-00	NUS-10B48-00	NUS-10B48-00	NUS-10B48-00
Web Qty. Req'd/Bundle	24	24	24	24	24
96" requires one Brick Ledge Panel & one Standard Panel to assemble one form unit					
Length - 96"	96" (2438mm)	96" (2438mm)	96" (2438mm)	96" (2438mm)	96" (2438mm)
Qty./Bundle	Includes: 2 Brick Ledge Panels & 2 Standard Panels				
Code #	NUS-10B96-00	NUS-10B96-00	NUS-10B96-00	NUS-10B96-00	NUS-10B96-00
Web Qty. Req'd/Bundle	24	24	24	24	24

Units come unassembled.

Insert webs required per bundle - refer to web order chart on left.

Refer to pages 28-33 for all related product accessories & tools. For additional information visit nudura.co.uk.

Double Sided Brick Ledge - Unassembled

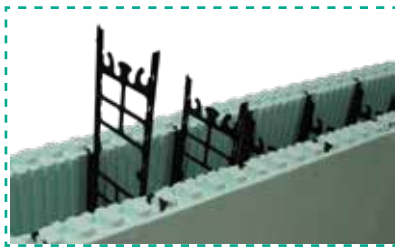
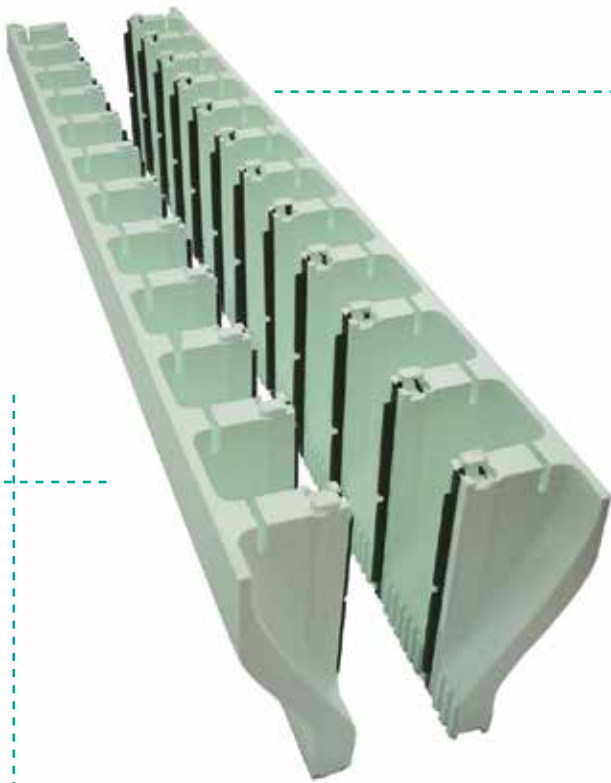

Close view of insert webs - available in 4"-12" (102-305mm) sizes

Unassembled Product Shown Above

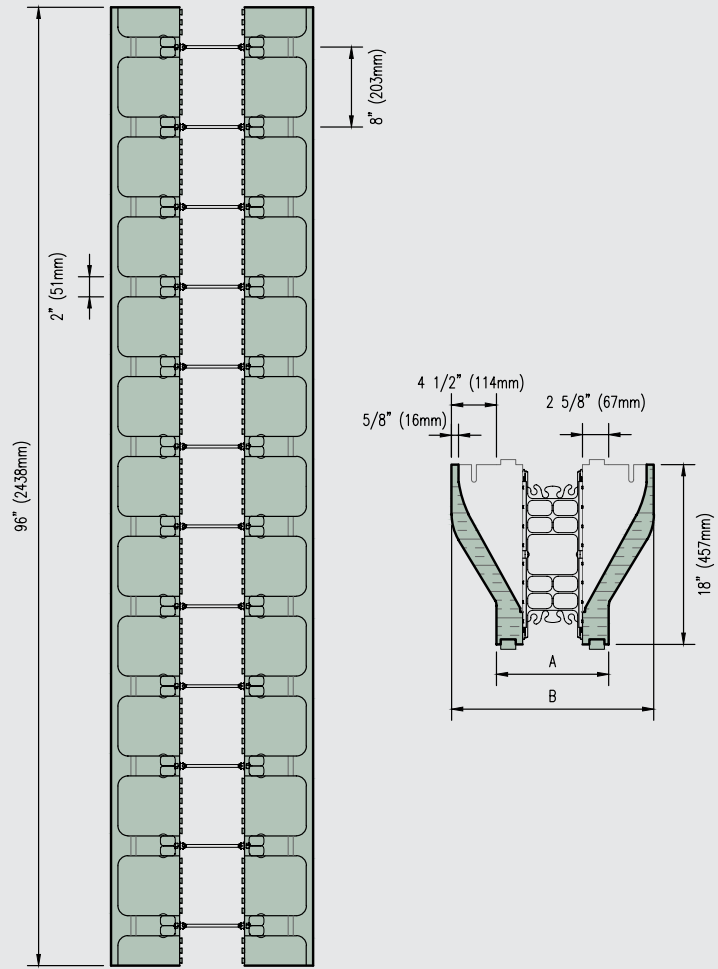

Unassembled 96" (2438mm) Double Sided Brick Ledge Shown Above

Insert Webs (Ordered Separately)

Small Box

Core Width	4" (102mm)	6" (152mm)	8" (203mm)	10" (254mm)	12" (305mm)
Qty./Box	100	100	100	100	100
Code #	NUS-IWEBS-04	NUS-IWEBS-06	NUS-IWEBS-08	NUS-IWEBS-10	NUS-IWEBS-12

Large Box

Core Width	4" (102mm)	6" (152mm)	8" (203mm)	10" (254mm)	12" (305mm)
Qty./Box	957	655	465	388	295
Code #	NUS-IWEBL-04	NUS-IWEBL-06	NUS-IWEBL-08	NUS-IWEBL-10	NUS-IWEBL-12

Visit the Resource Center on Nudura's website (nudura.co.uk/resource-center) for design details, BIM library, installation links & more.

Core Width	4" (102mm)	6" (152mm)	8" (203mm)	10" (254mm)	12" (305mm)
Overall Width A	9 1/4" (235mm)	11 1/4" (286mm)	13 1/4" (337mm)	15 1/4" (387mm)	17 1/4" (438mm)
Overall Width B	18 1/4" (463mm)	20 1/4" (514mm)	22 1/4" (565mm)	24 1/4" (616mm)	26 1/4" (667mm)
48" requires two Brick Ledge Panels (BRI-P) to assemble one double sided unit					
Length - 48"	48" (1219mm)	48" (1219mm)	48" (1219mm)	48" (1219mm)	48" (1219mm)
Qty./Bundle	Includes: 4 Brick Ledge Panels & 4 Standard Panels				
Code #	NUS-IOB48-00	NUS-IOB48-00	NUS-IOB48-00	NUS-IOB48-00	NUS-IOB48-00
Web Qty. Req'd/Bundle	24	24	24	24	24
96" requires two Brick Ledge Panels (BR96-P) to assemble one double sided unit					
Length - 96"	96" (2438mm)	96" (2438mm)	96" (2438mm)	96" (2438mm)	96" (2438mm)
Qty./Bundle	Includes: 2 Brick Ledge Panels & 2 Standard Panels				
Code #	NUS-IOB96-00	NUS-IOB96-00	NUS-IOB96-00	NUS-IOB96-00	NUS-IOB96-00
Web Qty. Req'd/Bundle	24	24	24	24	24

Units come unassembled.

Insert webs required per bundle - refer to web order chart on left.

Refer to pages 28-33 for all related product accessories & tools. For additional information visit nudura.co.uk.

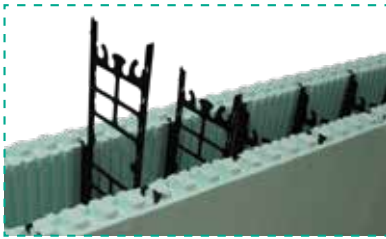
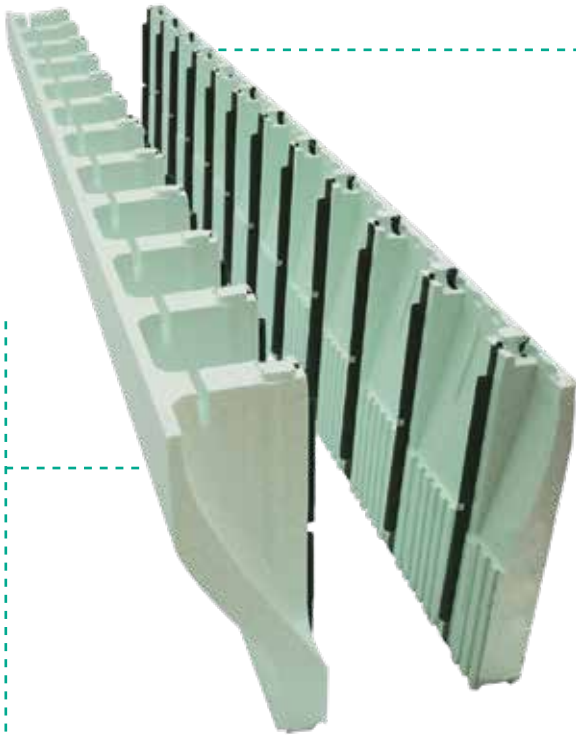

Close view of insert webs - available in 4"-12" (102-305mm) sizes

Unassembled Product Shown Above

Insert Webs (Ordered Separately)

Small Box

Core Width	4" (102mm)	6" (152mm)	8" (203mm)	10" (254mm)	12" (305mm)
Qty./Box	100	100	100	100	100
Code #	NUS-IWEBS-04	NUS-IWEBS-06	NUS-IWEBS-08	NUS-IWEBS-10	NUS-IWEBS-12

Large Box

Core Width	4" (102mm)	6" (152mm)	8" (203mm)	10" (254mm)	12" (305mm)
Qty./Box	957	655	465	388	295
Code #	NUS-IWEBL-04	NUS-IWEBL-06	NUS-IWEBL-08	NUS-IWEBL-10	NUS-IWEBL-12

Visit the Resource Center on Nudura's website (nudura.co.uk/resource-center) for design details, BIM library, installation links & more.

Refer to pages 28-33 for all related product accessories & tools. For additional information visit nudura.co.uk.

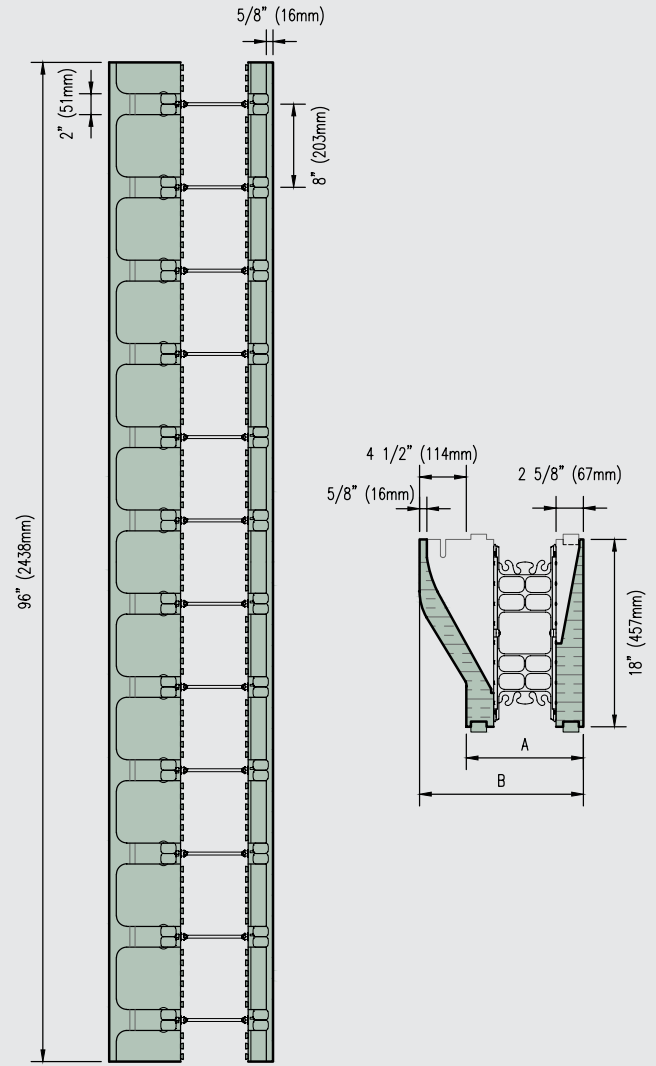

Unassembled 96" (2438mm) Brick Ledge and Taper Top Shown Above

Core Width	4" (102mm)	6" (152mm)	8" (203mm)	10" (254mm)	12" (305mm)
Overall Width A	9 1/4" (235mm)	11 1/4" (286mm)	13 1/4" (337mm)	15 1/4" (387mm)	17 1/4" (438mm)
Overall Width B	13 3/4" (349mm)	15 3/4" (400mm)	17 3/4" (451mm)	19 3/4" (502mm)	21 3/4" (552mm)
96" requires two Brick Ledge Panels (BRI-P) & one Taper Top Panel (TT96-P) to assemble one unit					
Length - 48"	48" (1219mm)	48" (1219mm)	48" (1219mm)	48" (1219mm)	48" (1219mm)
Qty./Bundle	Includes: 4 Brick Ledge Panels w/ 4 Standard Panels & 3 Taper Top Panels w/ 3 Standard Panels				
Code #	NUS-I0B48-00	NUS-I0B48-00	NUS-I0B48-00	NUS-I0B48-00	NUS-I0B48-00
Web Qty. Req'd/Bundle	24	24	24	24	24
96" requires one Brick Ledge Panel (BR96-P) & one Taper Top Panel (TT96-P) to assemble one unit					
Length - 96"	96" (2438mm)	96" (2438mm)	96" (2438mm)	96" (2438mm)	96" (2438mm)
Qty./Bundle	Includes: 2 Brick Ledge Panels w/ 2 Standard Panels & 3 Taper Top Panels w/ 3 Standard Panels				
Code #	NUS-I0B96-00 & NUS-I0T96-00	NUS-I0B96-00 & NUS-I0T96-00	NUS-I0B96-00 & NUS-I0T96-00	NUS-I0B96-00 & NUS-I0T96-00	NUS-I0B96-00 & NUS-I0T96-00
Web Qty. Req'd/Bundle	60	60	60	60	60

Units come unassembled.

Insert webs required per bundle - refer to web order chart on left.

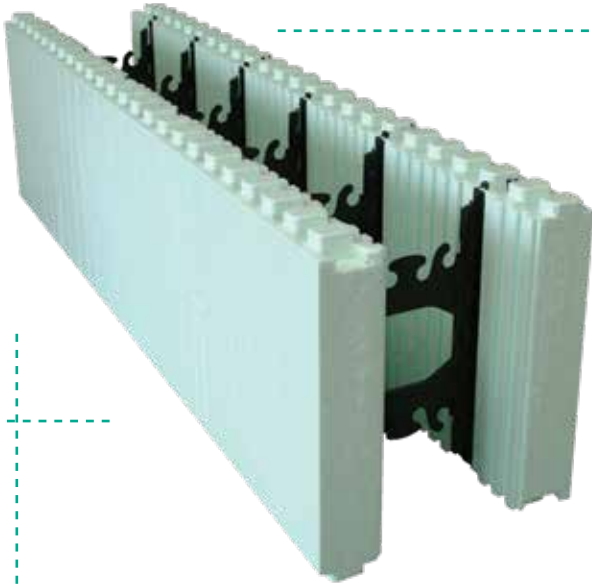

Close view of insert webs - available in 6"-12" (152-305mm) sizes

Product Shown Assembled Above

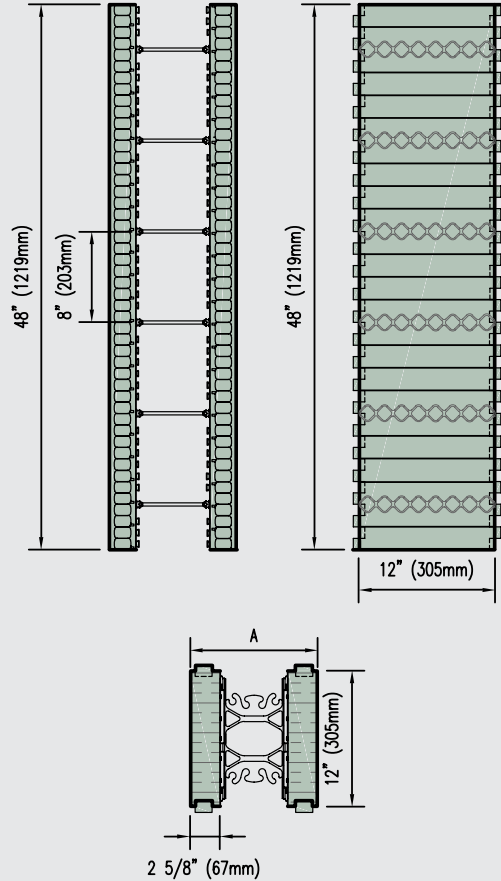

Insert Webs (Ordered Separately)

Core Width	4" (102mm)	6" (152mm)	8" (203mm)	10" (254mm)	12" (305mm)
Qty./Box		120	120	84	84
Code #		NUS-IOWEB-06	NUS-IOWEB-08	NUS-IOWEB-10	NUS-IOWEB-12

Core Width	4" (102mm)	6" (152mm)	8" (203mm)	10" (254mm)	12" (305mm)
Length		48" (1219mm)	48" (1219mm)	48" (1219mm)	48" (1219mm)
Overall Width A		11 1/4" (286mm)	11 1/4" (286mm)	11 1/4" (286mm)	11 1/4" (286mm)
Height		12" (300mm)	12" (300mm)	12" (300mm)	12" (300mm)
Qty./Bundle	Includes: 12 Optimizer Panels (6 pairs per bundle)				
Code #		NUS-10OPT-00	NUS-10OPT-00	NUS-10OPT-00	NUS-10OPT-00
Web Qty. Req'd/Bundle		36	36	36	36

Units come unassembled.

Insert webs required per bundle - refer to web order chart on left.

Visit the Resource Center on Nudura's website (nudura.co.uk/resource-center) for design details, BIM library, installation links & more.

Refer to pages 28-33 for all related product accessories & tools. For additional information visit nudura.co.uk.

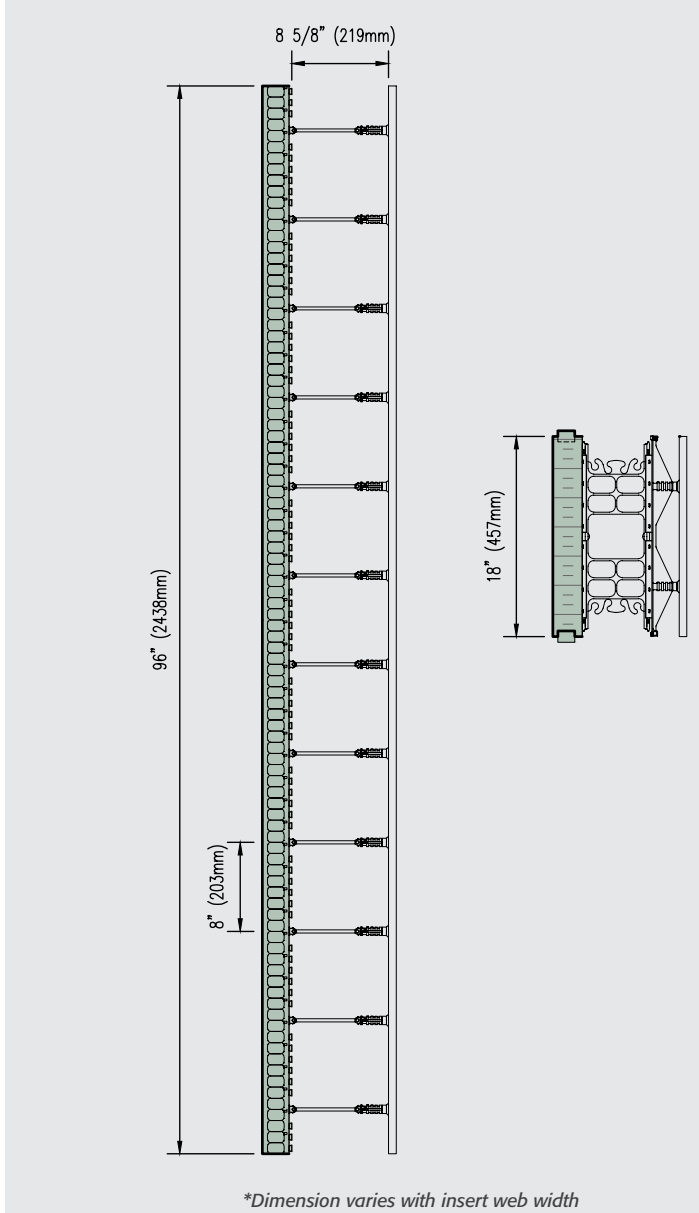
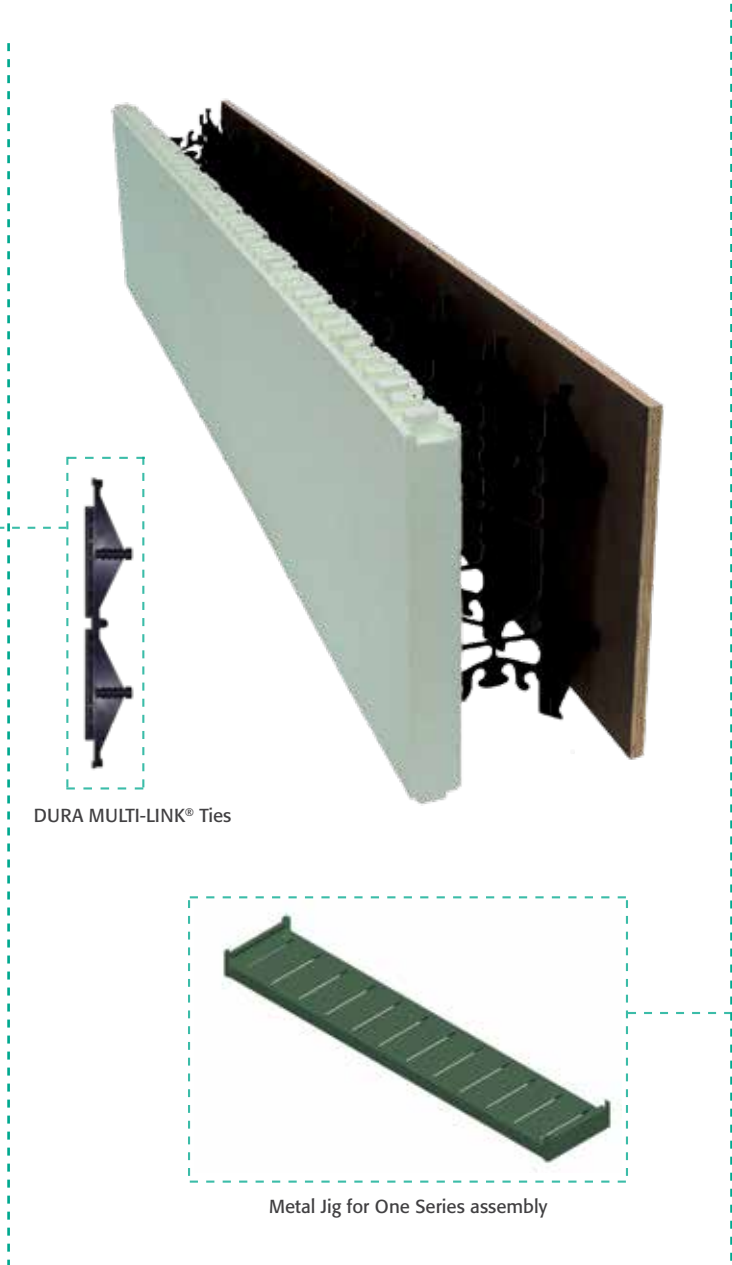

90° Corner Panel Options

90° Corner EPS Panel Outside

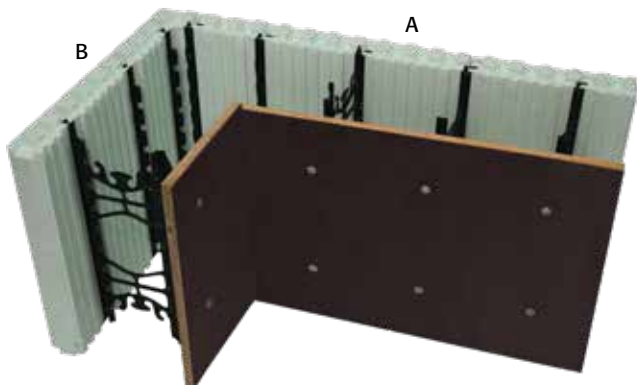

Note: Corner designation refers to EPS panel location.

90° Corner EPS Panel Inside

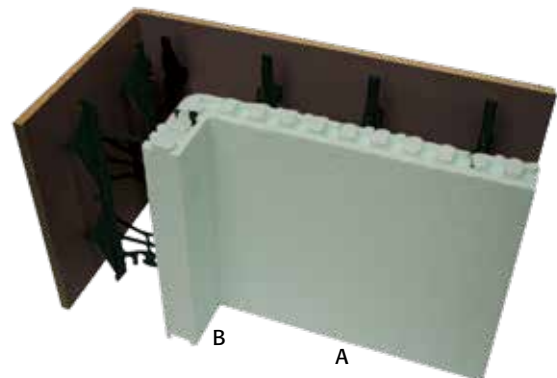

Visit the Resource Center on Nudura's website (nudura.co.uk/resource-center) for design details, BIM library, installation links & more.

Refer to pages 28-33 for all related product accessories & tools.
For additional information visit nudura.co.uk.
See next page for more information and codes to order the One Series.

NOTE:
To assemble a **SINGLE One Series Form Unit** you will require the following components:

STANDARD

- 1 x Standard EPS Panel
- 1 x Plywood Panel
- 24 x Screws
- 12 x DURA MULTI-LINK® Ties
- 12 x Insert Webs
- 1 x Jig

90° CORNER OUTSIDE

- 1 x 90° Outside EPS Panel
- 1 x Plywood Panel
- 8 x Screws
- 4 x DURA MULTI-LINK® Ties
- 4 x Insert Webs
- 1 x Jig

90° CORNER INSIDE

- 1 x 90° Inside EPS Panel
- 1 x Plywood Panel
- 12 x Screws
- 6 x DURA MULTI-LINK® Ties
- 4 x Insert Webs
- 1 x Jig

	Plywood*	Standard	90° Outside	90° Inside
Length A	96" (2438mm)	96" (2438mm)	37 5/8" (956mm)	20 3/8" (518mm)
Length B	-	-	21 5/8" (549mm)	4 3/8" (111mm)
Height	18" (457mm)	18" (457mm)	18" (457mm)	18" (457mm)
Qty./Bundle	1 Plywood Panel	6 Standard Panels	4 Panels	16 Panels
Code #	NUS-APLYN-00	NUS-IOPAN-00	NUS-E0E90-00	NUS-I0STW-00
Web Qty Req/Bundle	-	72	16	64

*Unassembled 45° Inside and Outside Panels available through special order only
* Plywood panels must be cut on-site.*

REQUIRED COMPONENTS

Hex Head Screw with Steel Flat Washer

Size	#10 x 2" (51mm)
Qty./Pail	1000
Code #	NUS-ASHEX-20

(2" (51mm) screws must be used – NUS-ASHEX-20)

DURA MULTI-LINK® Ties

Qty./Box	96 pieces
Code #	NUS-EMULT-00

Jig

Metal Jig for One-Series Form assembly

Qty.	1 Jig
Code #	NUS-AONEJ-00

Insert Webs (Ordered Separately)

Core Width	4" (102mm)	6" (152mm)	8" (203mm)	10" (254mm)	12" (305mm)
Qty./Box	100	100	100	100	100
Code #	NUS-IWEBS-04	NUS-IWEBS-06	NUS-IWEBS-08	NUS-IWEBS-10	NUS-IWEBS-12

Core Width	4" (102mm)	6" (152mm)	8" (203mm)	10" (254mm)	12" (305mm)
Qty./Box	957	655	465	388	295
Code #	NUS-IWEBL-04	NUS-IWEBL-06	NUS-IWEBL-08	NUS-IWEBL-10	NUS-IWEBL-12

Formply Inserts



Formply inserts are a component of the Plypan Panels and can now be purchased separately.

Qty./Box	2,400 pieces allowing production of 100 plypan panels
Code #	NUS-APLIN-00

Corner Connector



The corner connector is designed to securely connect two panels of plypan together at a 90° corner.

Length	10' (3m)
Code #	NUS-AONEC-00



Full length of connector not shown.

XR35 HIGHER R-VALUE

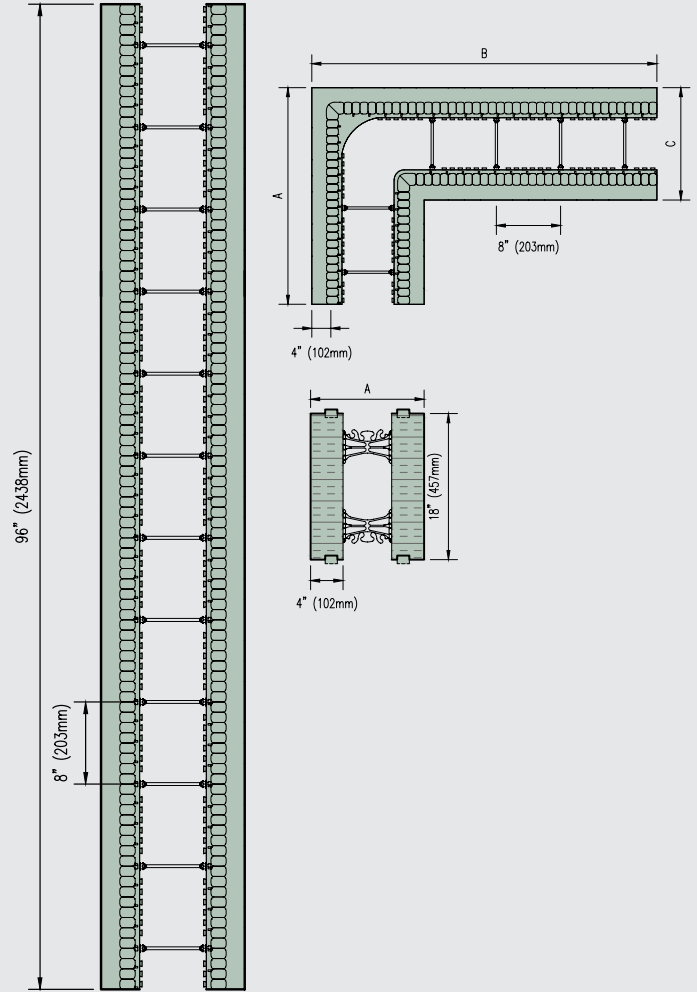
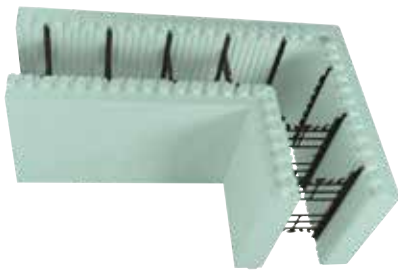
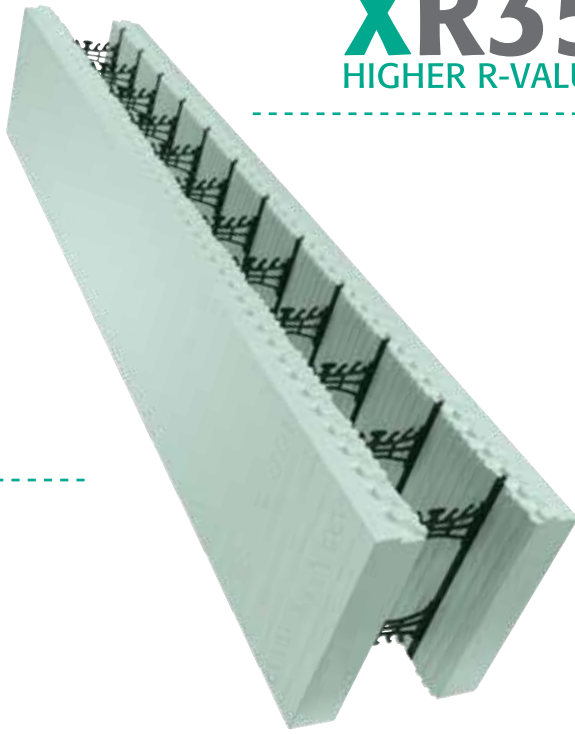

Webs are 5/8" away from the outside surface



MAY WE SUGGEST:

4" Heavy Duty Tape

Used for covering the interlock at the top of a wall to protect it from concrete getting into the interlock.



Qty./Box	24 PCS
Code #	NUS-ATPHD-04
Dimensions	4" x 72 Yd (96mm x 66m)

Visit the Resource Center on Nudura's website (nudura.co.uk/resource-center) for design details, BIM library, installation links & more.

Refer to pages 28-33 for all related product accessories & tools.
For additional information visit nudura.co.uk.

XR35 Standard Form

Core Width	6" (152mm)	8" (203mm)
Length	96" (2438mm)	96" (2438mm)
Width A	14" (356mm)	16" (406mm)
Height	18" (457mm)	18" (457mm)
EPS Thickness	4" (102mm)	4" (102mm)
Qty./Bundle	2	2
Code #	NUS-IX496-06	NUS-IX496-08

XR35 90° Corner Form

Core Width	6" (152mm)	8" (203mm)
Length A	27" (686mm)	29" (737mm)
Length B	43" (1092mm)	45" (1143mm)
Length C	14" (356mm)	16" (406mm)
Height	18" (457mm)	18" (457mm)
Qty./Bundle	4	4
Code #	NUS-IX490-06	NUS-IX490-08

XR35 Unassembled Panel

Length	96" (2438mm)
Height	18" (457mm)
EPS Thickness	4" (102mm)
Qty./Bundle	4 Panels (2 pairs per bundle)
Code #	NUS-IXPAN-00

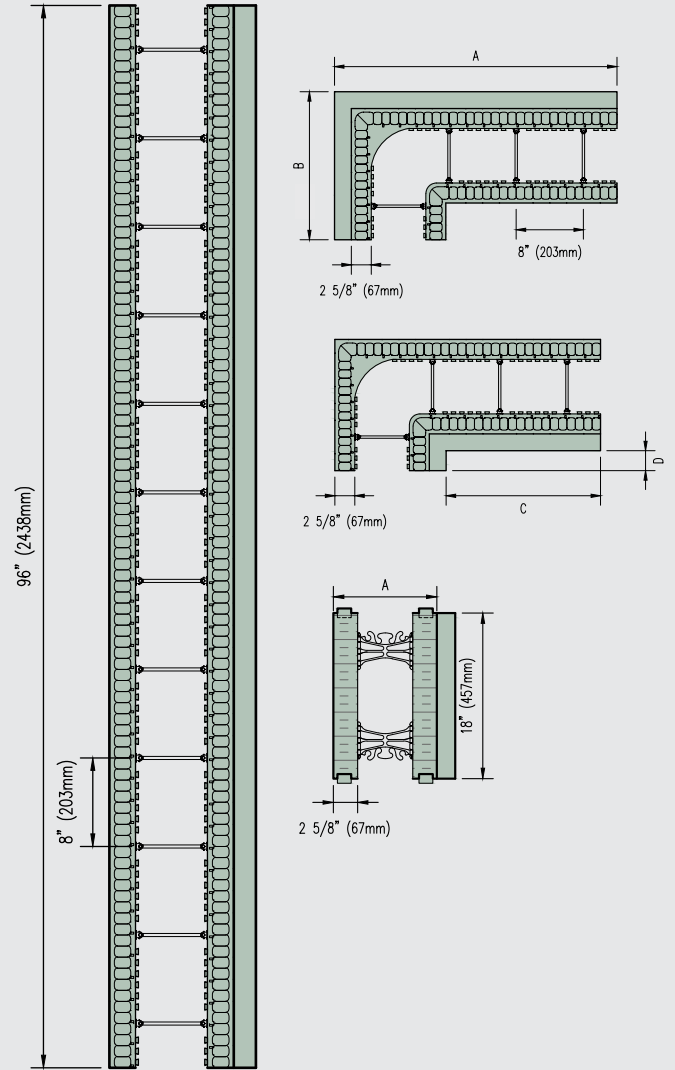
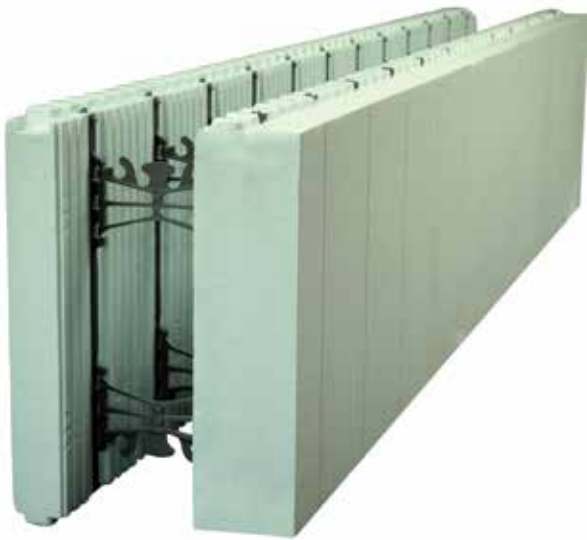

Information in the charts and the images show the 6" (152mm) form only

Standard Form Unit (Type 2 EPS Laminate on one side)

Thickness	1" (25mm)	2" (51mm)	4" (102mm)	6" (152mm)
Length	96" (2438mm)	96" (2438mm)	96" (2438mm)	96" (2438mm)
Height	18" (457mm)	18" (457mm)	18" (457mm)	18" (457mm)
Qty./Bundle	3	3	3	3
Code #	NUS-P1096-06	NUS-P2096-06	NUS-P4096-06	NUS-P6096-06

*Other form units & core thicknesses available through special request.
*Charts and images show 6" (152mm) form only.



1" (25mm) R-value - 28 RSI - 5.460 U-value - 0.21	2" (51mm) R-value - 32 RSI - 5.812 U-value - 0.18	4" (102mm) R-value - 40 RSI - 7.045 U-value - 0.15	6" (152mm) R-value - 48 RSI - 8.28 U-value - 0.12
--	--	---	--

Webs are 1 5/8" (41mm), 2 5/8" (67mm), 4 5/8" (117mm) and 6 5/8" (168mm) away from the outside when we laminate EPS to one side.

90° Form Unit - Outside (Long Side) (Type 2 EPS Laminate on one side)

Thickness	1" (25mm)	2" (51mm)	4" (102mm)	6" (152mm)
Length A	32 3/8" (813mm)	33 5/8" (854mm)	35 5/8" (905mm)	37 5/8" (956mm)
Length B	16 5/8" (422mm)	17 5/8" (448mm)	19 5/8" (498mm)	21 5/8" (550mm)
Height	18" (457mm)	18" (457mm)	18" (457mm)	8" (457mm)
Qty./Bundle	6	6	6	6
Code #	NUS-P1L90-06	NUS-P2L90-06	NUS-P4L90-06	NUS-P6L90-06

90° Form Unit - Inside (Short Side) (Type 2 EPS Laminate on one side)

Thickness	1" (25mm)	2" (51mm)	4" (102mm)	6" (152mm)
Length C	19 3/8" (492mm)	18 3/8" (467mm)	16 3/8" (416mm)	14 3/8" (365mm)
Length D	3 3/8" (86mm)	2 3/8" (60mm)	3/8" (10mm)	**
Height	18" (457mm)	18" (457mm)	18" (457mm)	18" (457mm)
Qty./Bundle	6	6	6	6
Code #	NUS-P1S90-06	NUS-P2S90-06	NUS-P4S90-06	NUS-P6S90-06

**On-site notching of EPS foam required.

Refer to pages 28-33 for all related product accessories & tools.
For additional information visit nudura.co.uk.



Build your own R-Value

The Nudura R-Value Plus+ inserts allow the ability to customise the desired amount of insulation needed to meet the specific requirements of any project. The inserts are available in 4 standard sizes: 1" (25mm), 2" (51mm), 4" (102mm) and 6" (152mm) and all 32" (812mm) long. Custom combinations can be created to provide further insulation value if desired and are compatible with core sizes ranging from 6" (152mm) to 12" (304mm).

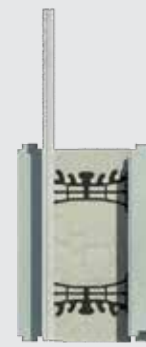

1" (25mm)
R-value - 3.1
RSI - 5.460
U-value - 0.183



2" (51mm)
R-value - 3.3
RSI - 5.812
U-value - 0.172



4" (102mm)
R-value - 4.0
RSI - 7.045
U-value - 0.142



6" (152mm)
R-value - 4.7
RSI - 8.28
U-value - 0.121

6" (152mm) concrete core R-Value ratings based on exterior brick finish

NUDURA Plus Series R-Value Inserts (EPS Foam Billet)

Thickness	1" (25mm)	2" (51mm)	4" (102mm)	6" (152mm)
Width	7 1/2" (190mm)	7 1/2" (190mm)	7 1/2" (190mm)	7 1/2" (190mm)
Height	32" (812mm)	32" (812mm)	32" (812mm)	32" (812mm)
Qty./Bundle	85	48	24	24
Code #	NUS-PIN32-01	NUS-PIN32-02	NUS-PIN32-04	NUS-PIN32-06

Refer to pages 28-33 for all related product accessories & tools.
For additional information visit nudura.co.uk.



The easy insulation for radiant heat.

HYDROFOAM® is the ideal radiant floor insulation product for residential and commercial construction projects that increases comfort and energy efficiency. HYDROFOAM maximises radiant floor heating by ensuring the heat is dispersed evenly throughout the entire floor area, providing building occupants with a comfortable living and working environment. HYDROFOAM offers installers a lightweight high density expanded polystyrene (EPS) product that increases installation speeds, is easily cut to meet any angle or radius while providing up to R-16 (RSI 2.82, U-value 0.35) insulation value.

Installation is fast and easy compared to traditional foam insulation. The 4' x 4' (1219mm x 1219mm) boards, available in three thickness, are easily installed with an overlapping interlock on all four sides, ensuring the boards are locked in place during installation. HYDROFOAM® utilises a 360° multidirectional friction fit anchor system that eliminates the need to tie the pex tubing to the wire mesh. Radiant heat piping is easily stepped into place in any direction required.

Product Highlights:

- Insulation under the concrete slabs
- 4' x 4' (1.2m x 1.2m) molded boards
- Only 4" (100mm) from base to nubs
- Available thicknesses: R-10 (RSI 1.76, U-value 0.57), 4" (102mm) - R-16 (RSI 2.82, U-value 0.35)
- Multi-directional anchoring
- Compatible with 1/2" (13mm) and 5/8" (16mm) diameter radiant tubing
- Radiant tube spacing is based on 3" (76mm) increments
- Shiplap/interlocking on all 4 sides
- Eco-friendly - No CFCs of HCFCs
- 100% recyclable
- Resistant to water and moisture
- Qualifies as low emitting materials**

Sheet Thickness	2 1/2" (64mm)	4" (102mm)
Sheet Size	48" x 48" (1219 x 1219mm)	48" x 48" (1219 x 1219mm)
Qty./Bundle	10	6
Code #	NUS-F0RHF-25	NUS-F0RHF-40

** Conforms to LEED 4.1 CPDH testing standards

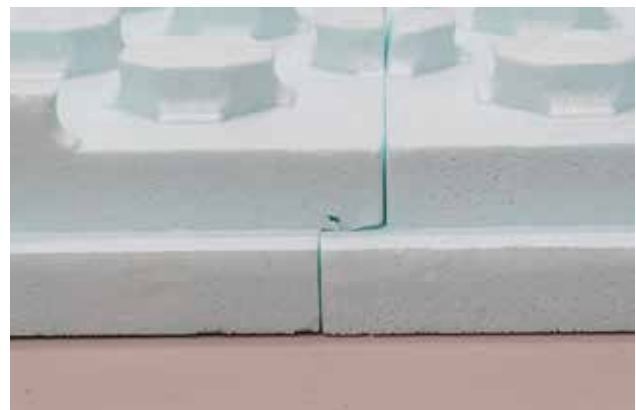

For more information download our Technical Data Sheet on nudura.co.uk



All Surface Insulation

THERMOFOAM® 2' x 8' (610mm x 2438mm) insulation differs from conventional insulation products. The THERMOFOAM features a unique interlocking design which provides easier installation and air tightness, and is available in thicknesses of 1 1/4" (32mm), 1 7/8" (48mm) and 2 1/2" (64mm) and offers R-values of R-5 (RSI 0.88, U-value 1.14) to R-10 (RSI 1.85, U-value 0.54) with three different foam densities to better meet the many insulation requirements of all types of construction.

Installation of THERMOFOAM is quick and easy! Use the offcut from the first row for the next row so the joints can be staggered. Place the THERMOFOAM panels together using the unique interlocking system. If necessary, install a vapour barrier membrane (according to local building code).

Economical:

- Quick and easy installation
- Permanent insulation value
- Excellent quality-price ratio
- Increased energy savings

Superior Performance:

- Interlocking airtight design
- Moulded board: superior physical properties
- More flexibility than a cut board

Sustainable:

- 100% recyclable
- No CFCs or HCFCs
- Inorganic and rot-proof materials
- Resistant to water and moisture that can cause mildew
- Non-toxic (90% air and 2% material) temperature
- For interiors and exteriors of any type of construction
- Increased comfort as a result of uniform temperature



THERMOFOAM 20 (Pink)

	1 1/4" (32mm) - Overlap	1 7/8" (48mm) - T&G	2 1/2" (64mm) T&G
Size	24" x 96" (610 x 2438mm)	24" x 96" (610 x 2438mm)	24" x 96" (610 x 2438mm)
Qty./Bundle	15	10	7
Code #	NUS-FTK11-42	NUS-FTK17-82	NUS-FTK21-52

THERMOFOAM 30 (Grey)

	1 1/4" (32mm) - Overlap	1 7/8" (48mm) - T&G	2 1/2" (64mm) T&G
Size	24" x 96" (610 x 2438mm)	24" x 96" (610 x 2438mm)	24" x 96" (610 x 2438mm)
Qty./Bundle	10	8	6
Code #	NUS-FTR12-53	NUS-FTR17-83	NUS-FTR21-53

THERMOFOAM 40 (Yellow)

			2 1/2" (64mm) T&G
Size			24" x 96" (610 x 2438mm)
Qty./Bundle			6
Code #			NUS-FTY21-24

For more information download our Technical Data Sheet on nudura.co.uk



Foundation Wall Insulation

HOMEGA® is a 4' x 8' (1219mm x 2438mm) individually molded insulation panel with three integrated furring strips at 16" (406mm) apart centre and shiplapped on all 4 sides. It is a unique, patented, 2-in-1 system offering superior performance. It can be used to insulate foundation walls and floors, interior and exterior walls and ceilings. The panel comes in thicknesses of 2 5/8" (67mm), 3 1/2" (89mm) and 3 7/8" (98mm), allowing you to reach an R value of R-10 (RSI 1.76, U-value 0.57) to R-15 (RSI 2.64, U-value 0.38)

For basement insulation, install the boards using mechanical anchors. In places where the panels overlap and need to be cut; seal the space with Nudura low-expansion spray foam. Install drywall directly to the insulation board's furring strips. For floor insulation, glue the panel with a solvent-free glue to prevent movement (optional). Cross the plywood joints with HOMEGA insulation board's joints and screw at 12" (305mm) intervals over the length of the furring strips. Finally, apply the selected finishing material.

Economical:

- Quick and easy installation
- Permanent insulation value
- 2-in-1 product: insulates concrete slab and supports pipes
- Energy Savings: reduced heating bills

Insulation Advantages:

- Molded panel: superior physical properties
- Flexibility to cut any shape or size
- Better deal: shiplapped on all sides

Sustainable:

- 100% recyclable
- No CFCs or HCFCs
- Inorganic and rot-proof materials
- Resistant to water and moisture that can cause mildew
- Qualifies as low emitting materials**
- Increased comfort as a result of uniform temperature
- Interlocking air tight design
- Available with wood or plastic furring strips



Sheet Thickness	2 5/8" (67mm)	3 1/2" (89mm)	3 7/8" (98mm)
Sheet Size	48" x 96" (1219 x 2438mm)	48" x 96" (1219 x 2438mm)	48" x 96" (1219 x 2438mm)
Qty./Bundle	6	4	4
Strapping*	Wood Polystyrene	Wood Polystyrene	Wood Polystyrene
Code #	NUS-FCW25-81 NUS-FCP25-81	NUS-FCW31-21 NUS-FCP31-21	NUS-FCW37-81 NUS-FCP37-81

*Polystyrene strapping only to be used in retrofit applications
** Conforms to LEED 4.1 CPDH testing standards

#10 Wood Screw

#10 Screws	4" (102mm)	5" (127mm)	6" (152mm)
Qty./Box	500	500	500
Code #	NUS-ASCRW-40	NUS-ASCRW-50	NUS-ASCRW-60

1/4 Concrete Screws

Concrete Screws	5" (127mm)	5" (127mm)	6" (152mm)
Qty./Pail	50	300	50
Code #	NUS-ASCCS-50	NUS-ASCCS-50	NUS-ASCCS-60

Nudura Form Accessories

Brick Ledge Extension & 6" (152mm) Screw & Plastic Washer

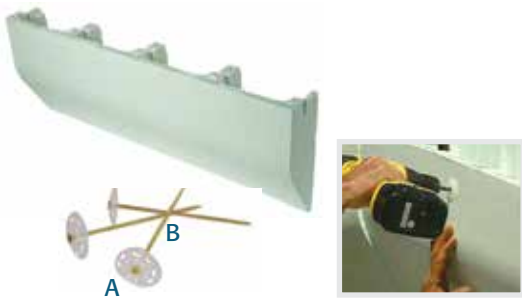

Brick Ledge Extensions are used for supporting standard brick or stone veneer finishes, when constructing brick ledges at corners, and can be installed to meet any elevation change or slope.

Length	32" (813mm)
Width	4 1/2" (114mm)
Height	13" (330mm)
Qty./Bundle	14
Code #	NUS-ABLEX-00

A. Plastic Washer

Qty./Box	250
Code #	NUS-ASCPW-00

B. 6" (152mm) Screw

Qty./Box	500
Code #	NUS-ASCRW-60

Screw & Plastic Washer to be used to attach the Brick Ledge Extension to the form wall or to attach additional foam panels for increased insulation to a building.

End Cap



End Cap (with Fastening Strip) can be used to terminate a wall. It can also be used as a buck material for windows.

Width	4" (102mm)	6" (152mm)	8" (203mm)	10" (254mm)	12" (305mm)
Height	18" (457mm)	18" (457mm)	18" (457mm)	18" (457mm)	18" (457mm)
EPS Thickness	2 5/8" (67mm)	2 5/8" (67mm)	2 5/8" (67mm)	2 5/8" (67mm)	2 5/8" (67mm)
Qty./Box	57	40	30	35	30
Code #	NUS-A0ECF-04	NUS-A0ECF-06	NUS-A0ECF-08	NUS-A0ECF-10	NUS-A0ECF-12

Height Adjuster & Height Adjuster Tie



The Height Adjuster (with Fastening Strip) combined with the Height Adjuster Tie can increase the height of a wall by 3" (75mm) increments. The Height Adjuster ties allow the foam panels to be connected together. Site assembly required.

Length	32" (813mm)
Height	3" (76mm)
Qty./Bundle	80
Code #	NUS-AHDJF-00

Height Adjuster Tie

Core Width	4" (102mm)	6" (152mm)	8" (203mm)	10" (254mm)	12" (305mm)
Qty./Box	100	100	100	100	80
Code #	NUS-AHADT-04	NUS-AHADT-06	NUS-AHADT-08	NUS-AHADT-10	NUS-AHADT-12

One NUS-AHDJF-00 Bundle requires 160 Height Adjuster Ties

FORM-LOCK



Full length of FORM-LOCK not shown.

FORM-LOCK is used to maintain wall straightness. Other uses include wall alignment for vertical stack joints. Each bundle has 100' (30m) of FORM-LOCK.

Available for 6" - 12" (152 - 305mm) Standard Forms only.

Core Width	6" (152mm)	8" (203mm)	10" (254mm)	12" (305mm)
Length	10' (3m)	10' (3m)	10' (3m)	10' (3m)
Qty./Bundle	10	10	10	10
Code #	NUS-ABL0K-06	NUS-ABL0K-08	NUS-ABL0K-10	NUS-ABL0K-12

Lintel Cavity Closure



The Lintel Cavity Closure provides installers a product that provides insulation above and below the window to minimise thermal bridging. The Nudura Lintel Cavity Closure is available in a standard 2" (50mm) thickness.

Core Width	4" (102mm)	6" (152mm)	8" (203mm)	10" (254mm)	12" (305mm)
Qty./Box	84	60	48	36	36
Code #	NUS-PLINT-04	NUS-PLINT-06	NUS-PLINT-08	NUS-PLINT-10	NUS-PLINT-12



4-Way Web Connector

Qty./Box	100 PCS
Code #	NUS-A4XWC-00

The 4-Way Web Connector allows two or more insert webs to be connected together and used with the panel system to create wider form sizes. It also can be used to create forms of different shapes and sizes. Increased design flexibility.



A

ICF Hanger System

(Formally; Multi Purpose Anchor Hanger System)

The ICF Hanger System is available in both standard Flat and 45-degree angle plates. In conjunction with Stamped Bearing Bracket the Hanger System provides a solid wood floor or wood roof connection to the Nudura wall. An inexpensive yet labour-friendly connection system.

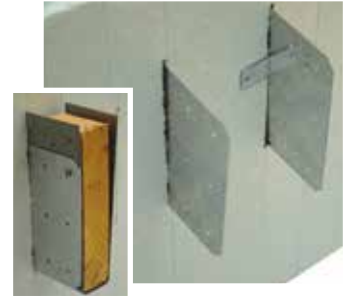

D

Retrofit Brackets are also available and used when a change occurs after the concrete has been placed into the forms and cures.



B

A. ICF Hanger Insert Plate
D. Stamped Bearing Bracket
*(*12 Screws Incl. - Box of 170)*

Qty./Box	50 PCS
Code #	NUS-AIHIP-00

Qty./Box	25 PCS
Code #	NUS-AISBB-00



C

B. 45° ICF Hanger Insert Plate
1/4" x 4" Hex Lag Screws Incl. - Box of 60

Qty./Box	20 PCS
Code #	NUS-AIHIP-45

C. Retrofit Bracket
Lag Bolts not included.

Qty./Box	12 PCS
Code #	NUS-AIRFB-00



Transition Bracket

Qty./Box	100 PCS
Code #	NUS-ATRBR-00

The Transition Bracket allows two different form widths to be connected together. Primary use is to create a ledge to support brick or a floor system.



Rebar Clip

Qty./Box	200 PCS
Code #	NUS-ARCLP-00

The Rebar Clip is designed to support horizontal rebar in the bottom web of the Nudura form, eliminating the need to tie wire or zip-tie the bar in place.





Vertical Joint Clip

Qty./Box	200 PCS
Code #	NUS-A0VIC-00

The Vertical Joint Clip is designed to connect the forms together at the vertical joints. It replaces having to tie wire or tape forms together while providing a solid connection using minimal amount of labour to install.

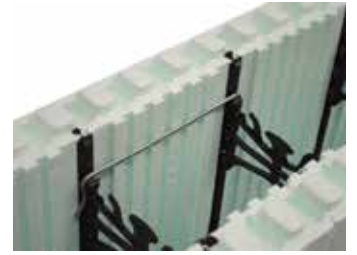

Product may be different than shown. Product subject to change.

Hex Head Screw with Steel Flat Washer

Size	#10 x 2" (51mm)	#10 x 2.5" (64mm)	#10 x 3" (76mm)
Qty./Box	1000 PCS	1000 PCS	1000 PCS
Code #	NUS-ASHEX-20	NUS-ASHEX-25	NUS-ASHEX-30

The #10 screw can be used to connect the Nudura Alignment System to the forms. Other uses include attachment of strapping or buck material to concrete. Available in 2" (51mm), 2 1/2" (64mm), and 3" (76mm) lengths. Two 1/4" (6mm) nut drivers included per pail.



10 Piece Bit Kit

Qty./Box	12 KITS
Code #	NUS-ABITK-00

Contact your local distributor for more information on how to order.

Ten piece kits include five 1/4" magnetic nutsetters which can be used with any of Nudura's Hex Head Screws with Steel Flat Washers, as well as five #2 red square driver bits. The durable plastic case keeps all the bits together in one convenient spot and limits trying to find drivers bits on site during construction.



V-Clip

Qty./Box	250 PCS
Code #	NUS-AVCLP-00

The V-Clip is used to connect a Nudura panel to a concrete floor. It allows the contractor to support the panel without additional materials used on the outside of the wall.



Easy Buck

Qty./Box	10 PCS
Code #	NUS-AWBCK-00
Dimensions	10' (3m) Long

The Easy Buck is used for window and door jambs and allows nominal sized lumber to fit between the Expanded Polystyrene (EPS) panels. Primary uses are for doors and windows. Each bundle contains 100' (30m) of Easy Buck.



Nudura Accessories



Brick Ties Cast-In Place (Galvanized Steel)

Qty./Box	100 PCS
Code #	NUS-ABRKG-00

Brick Ties Cast-In Place (Stainless Steel)

Qty./Box	100 PCS
Code #	NUS-ABRKS-00

Cast-In Place Brick Tie and Pintle – Enables solid anchorage of veneer masonry through exterior foam to concrete core; tested to meet ASTM D754 (USA) and CSA-A370 (CAN) std. requirements for masonry anchors.

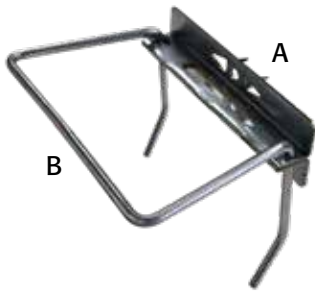

Surface Mount

Brick Ties (A)

Qty./Box	100 PCS
Code #	NUS-ASBRK-00

Pintle (B)

Qty./Box	100 PCS
Code #	NUS-APNTL-00

Surface Mount Brick Tie and Pintle – Designed to be fastened with two Nudura Hex head Screws anywhere on the Nudura fastening strip. This tie will accept Nudura Pintels and other smaller dimension pintels tested to meet ASTM D754 (USA) and CSA-A370 (CAN) std. requirements for masonry anchors.



Fiber Tape

Qty./Box	36 PCS
Code #	NUS-ATAPE-01
Dimensions	1" x 60 Yd (25mm x 55m)

Fiber Tape is used to provide additional EPS support for field cut forms that have more than 4" (100mm) of EPS extending past the last web, brick ledge forms in corner conditions, and radius panels.

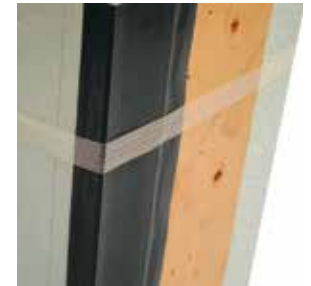

4" Protective Tape

Qty./Box	18 PCS
Code #	NUS-ATPCL-04
Dimensions	4" x 72 Yd (96mm x 66m)

The 4" (100mm) Protective Tape is used for covering the interlock at the top of a wall to prevent concrete from flowing into the interlock.



4" Heavy Duty Tape

Qty./Box	24 PCS
Code #	NUS-ATPHD-04
Dimensions	4" x 72 Yd (96mm x 66m)

The 4" (100mm) Heavy Duty Tape is used for covering the interlock at the top of a wall to prevent concrete from flowing into the interlock.





NUBASE Parging Mix - Coverage of 75 sq. ft. (7m²)

Qty.	1 BAG
Code #	NUS-APARG-00

The NUBASE parge mix is a dry cementitious product that is used to cover exposed EPS that is not covered by an exterior finish. Used in conjunction with Fiber Mesh.



Fiber Mesh - Coverage of 475 sq. ft. (44m²)

Qty.	1 ROLL
Code #	NUS-AMESH-00

The Fiber Mesh gets embedded into the parge coat to give it strength.



Foam Gun (Metal Handle)

Qty.	1 GUN
Code #	NUS-AGUNM-00

The metal handle Foam Gun is compatible with the Nudura Low Expansion Foam 24oz (680g) cans. The Nudura Low Expansion Foam can be used for a number of different tasks on site.

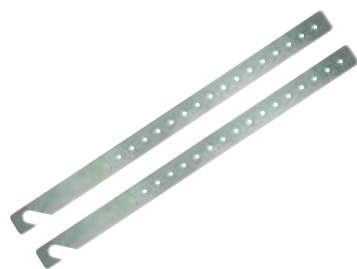

T-Form Support Strap

Qty./Bundle	30 PCS
Code #	NUS-ATSTP-00

Created to aid in installation and support on-site cut T-connections. The steel straps are designed to hook over the internal reinforcing on the main wall of a T-Wall connection and be secured to the fastening strips of the "T" portion of the wall.



Folding Saw

Qty.	1 SAW / 12 Per Box
Code #	NUS-AFSAW-00

A great combination of cutting power and comfort, whether you're cutting overhand or making undercuts in the form. The soft grip handle provides a secure grip and the saw folds and locks for space-saving storage and safe transportation.





Waterproofing Membrane - 225 sq. ft. (21m²)

A. Summer Grade

Qty.	1 ROLL
Code #	NUS-AWPRF-00

B. Winter Grade

Qty.	1 ROLL
Code #	NUS-AWPRF-02

The Peel & Stick Waterproofing Membrane is used for below grade dampproofing of the Nudura walls. Other uses for the Waterproofing Membrane include drain flashings around window and door openings and brick ledge through wall flashings. Available in summer and winter grades.



Membrane Primer

Qty.	1 PAIL
Code #	NUS-AWPRM-00

The Membrane Primer is designed for use with Nudura's peel and stick waterproof membranes. This polymer emulsion-based primer is available in a 19L (5 gallon) pail, with a coverage of approximately 1020 sq. ft. (95m²) of wall area per pail. The membrane primer can help improve adhesion of Nudura's Waterproofing Membrane in specific areas.



Rebar Bender Cutter

Qty.	1 Bender/Cutter
Code #	NUS-AREBC-00

The Rebar Bender Cutter is used for cutting and bending reinforcing steel used in the Nudura wall system. Comes with two cutting heads which will cut up to #5 (15M) reinforcing steel. The rollers used for bending the steel are capable of handling up to a #5 (15M) bar.



Nudura Alignment System

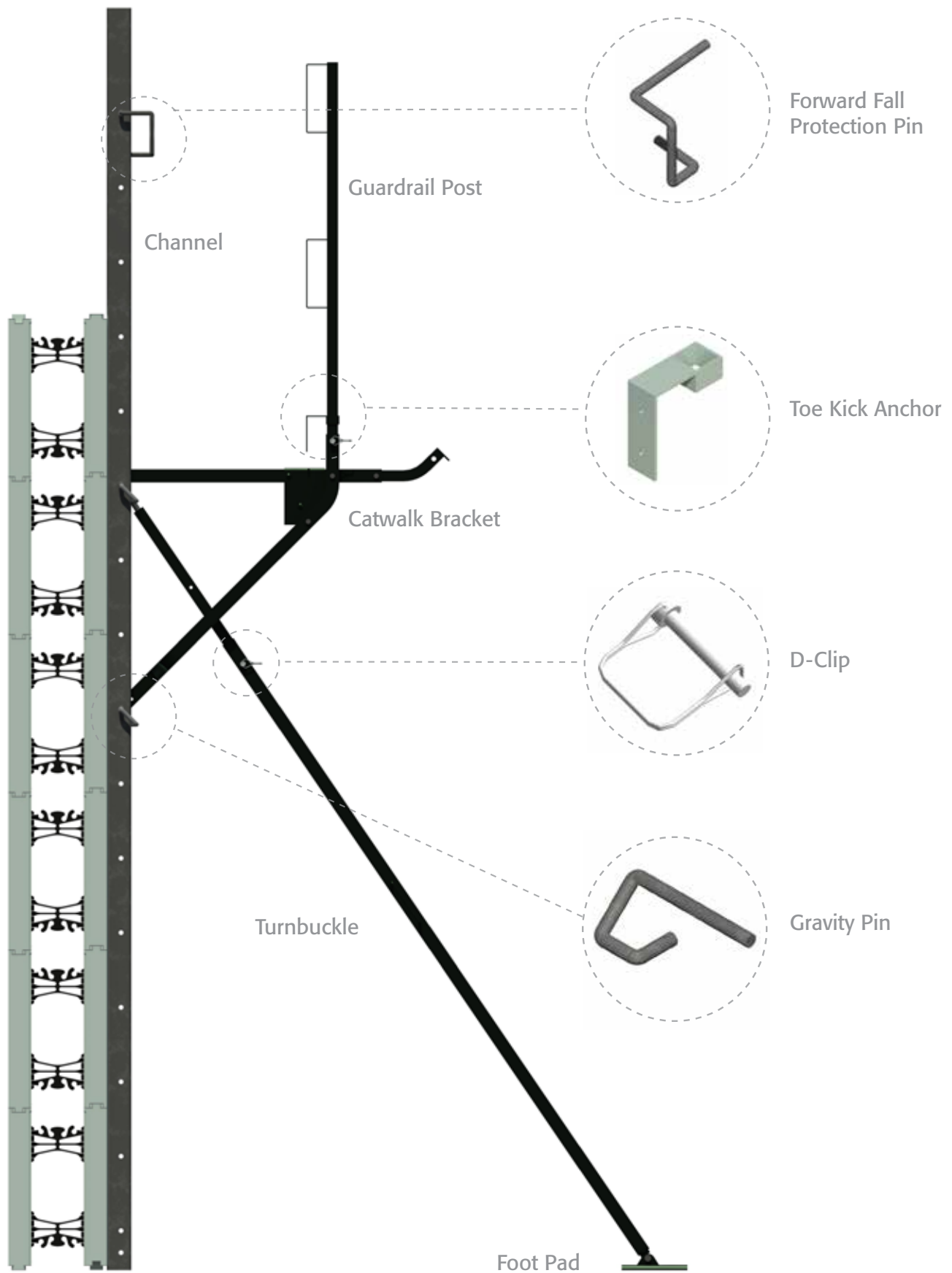

Diagram above illustrates both Square & Round Tube Bracing. For reference only.

Nudura Alignment System

Square Tube Bracing - No Wall Channels

Includes	20 Guardrail Post 20 Catwalk Brackets 20 Turnbuckles 40 Gravity Pins
Code #	NUS-BRACN-00

Packaged on a wooden skid.
 ++Metal Bracing Rack available to order separately.
 Wall Channels ordered separately. See right.

Wall Channels (Bracing Not Included)

8' (2.4m)	NUS-BSCHA-08*
10' (3m)	NUS-BSCHA-10
12' (3.6m)	NUS-BSCHA-12
Channels/Bdl	20

Square Tube Bracing w/10' Wall Channels

Includes	20 - 10' Wall Channels 20 Guardrail Post 20 Catwalk Brackets 20 Turnbuckles 40 Gravity Pins
Code #	NUS-BSTRN-10**

++Packaged in Metal Bracing Rack

Square Tube Bracing w/12' Wall Channels

Includes	20 - 12' Wall Channels 20 Guardrail Post 20 Catwalk Brackets 20 Turnbuckles 40 Gravity Pins
Code #	NUS-BSTRN-12**

++Packaged in Metal Bracing Rack

Round Tube Bracing w/10' Wall Channels

Includes	20 - 10' Wall Channels 20 Guardrail Post 20 Catwalk Brackets 20 Turnbuckles 40 Gravity Pins
Code #	NUS-BSTRN-10**

++Packaged in Metal Bracing Rack

Round Tube Bracing w/12' Wall Channels

Includes	20 - 12' Wall Channels 20 Guardrail Post 20 Catwalk Brackets 20 Turnbuckles 40 Gravity Pins
Code #	NUS-BSTRN-12**

++Packaged in Metal Bracing Rack

D Clip

Includes	100/Box
Code #	NUS-BDCLP-00

Gravity Pins - 6" (152mm)

Includes	50/Box
Code #	NUS-BSGPN-00

Forward Fall Protection Pin

Includes	40/Box
Code #	NUS-BFFPN-00

Toe Kick Anchor

Includes	40/Box
Code #	NUS-BSTTK-00



++Metal Bracing Rack - Code # NUS-BRCKS-10

*Special Order - production time required to fulfill order.
 **Also available assembled as a European version NUS-BSTRE-10

Nudura Tall Wall Adapter

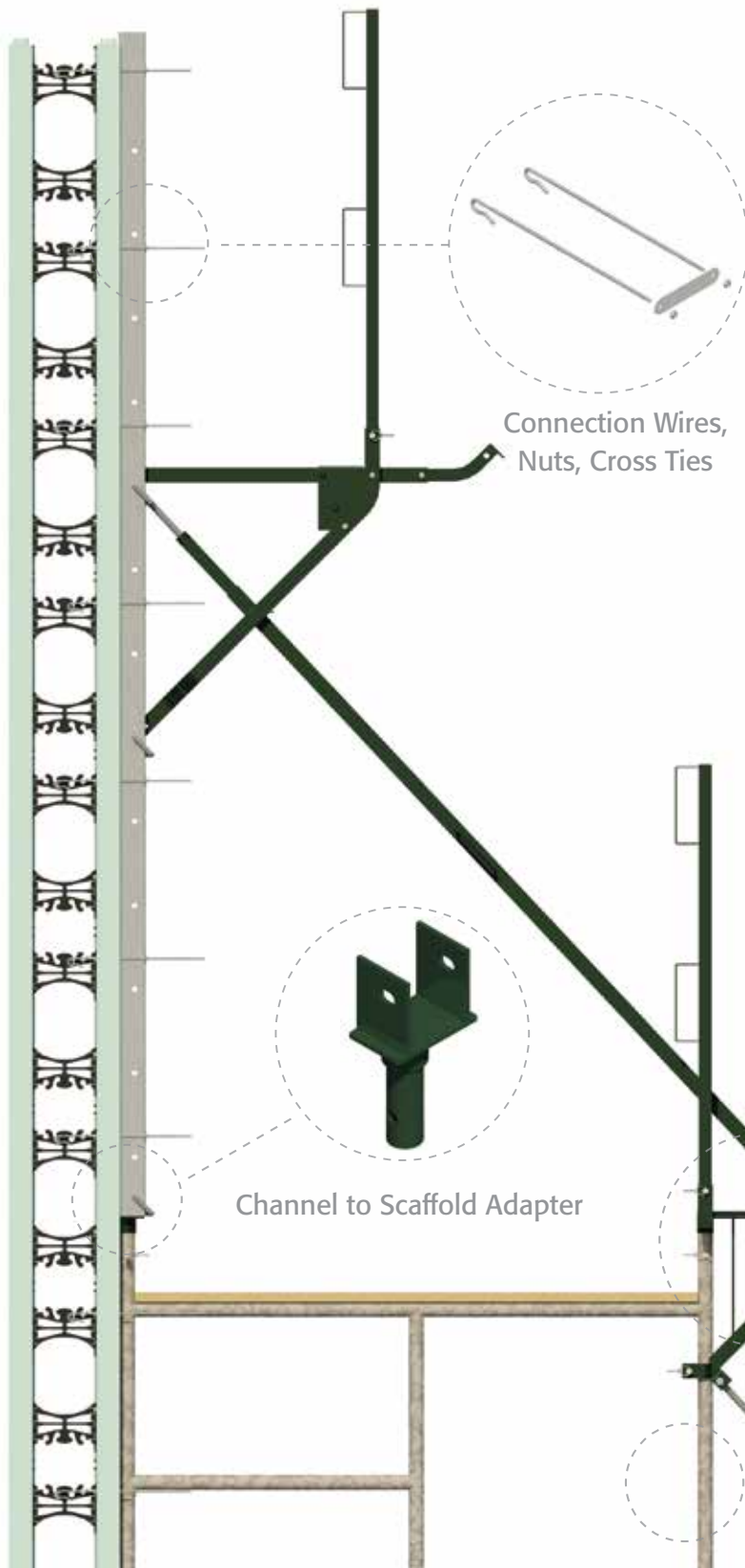

Nudura Tall Wall Adapter Kit

Includes	20 Scaffold to Turnbuckle Adapters 20 Channel to Scaffold Adapters 20 Scaffold to Scaffold Adapters
Code #	NUS-BTWKT-00*

Tall Wall Nut & Cross Tie Kit

Includes	50 Cross Ties 100 Nuts
Code #	NUS-BNTCR-00

Tall Wall Connector Wires - 14" (356mm)

Includes	100 Connector Wires
Code #	BTWCW-00

Scaffold to Turnbuckle Adapter



Channel to Scaffold Adapter



Scaffold to Scaffold Adapter



Diagram above illustrates Tall Wall Adapter Kit on Bracing. For reference only.

***Special Order** - production time required to fulfill order.
NOTE: Tall Wall only compatible with square tube bracing.

Visit www.tremcocpg-asiapacific.com to find your nearest office location.

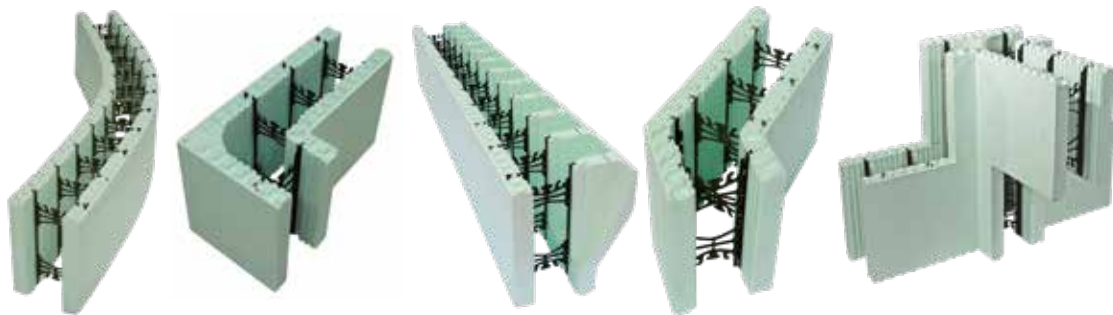

By using Nudura Insulated Concrete Forms to build your next structure you can ensure you are choosing the best building solution available today.

Scan to learn more about the innovation behind NUDURA ICFs



The information contained in this Nudura® Product Catalogue is presented only for the purpose of providing information on the various products composing the Nudura Integrated Building Technologies and any associated accessories (the "Nudura Products"). This Product Catalogue SHOULD NOT be used as a substitute for professional engineering consultation. Nudura makes no general warranties to the specific applicability of any of the products to any or all situations for which a designer may elect their specific use. Final amendment or modification to suit the exact circumstance of employment of any such products is the responsibility of the project designer. Nudura does not have any control over the installation or workmanship used in the assembly or installation of the Nudura Products. Nudura and its affiliated entities shall not be held liable for any general, special, direct, indirect or consequential damages, including bodily harm, which may be suffered by any person including, without limitation, an installer, contractor, subcontractor, architect, engineer, homeowner or building owner due to the use, assembly or installation of the Nudura Products. The Nudura Products are sold subject to the Nudura 30-Year Limited Warranty. Nudura®, N Design®, Integrated Building Technology®, Building Has Evolved®, DURALOK Technology®, DURAFOLD Technology®, DURAMAX Technology® and DURA MULTI-LINK® are trademarks of Nudura Inc.

All other trademarks cited herein are the property of their respective owners.

Follow us on:

Tremco Construction Products Group (CPG) represents the combined power of brands including Dryvit, NewBrick, Nudura, Willseal, and Tremco, along with Tremco CPG affiliates Flowcrete, illbruck, Nullifire, Vandex and Euclid Chemical.

Our products and services empower teams to develop, design, restore and engineer structures that are more efficient to build and maintain, are virtually impervious to the elements and can provide any look desired.

www.tremcocpg-asiapacific.com

